



# Operation Chart

## Full Size Copying

### ■ When copying the same size as the original (1:1)

Copy size and copy density are automatically selected

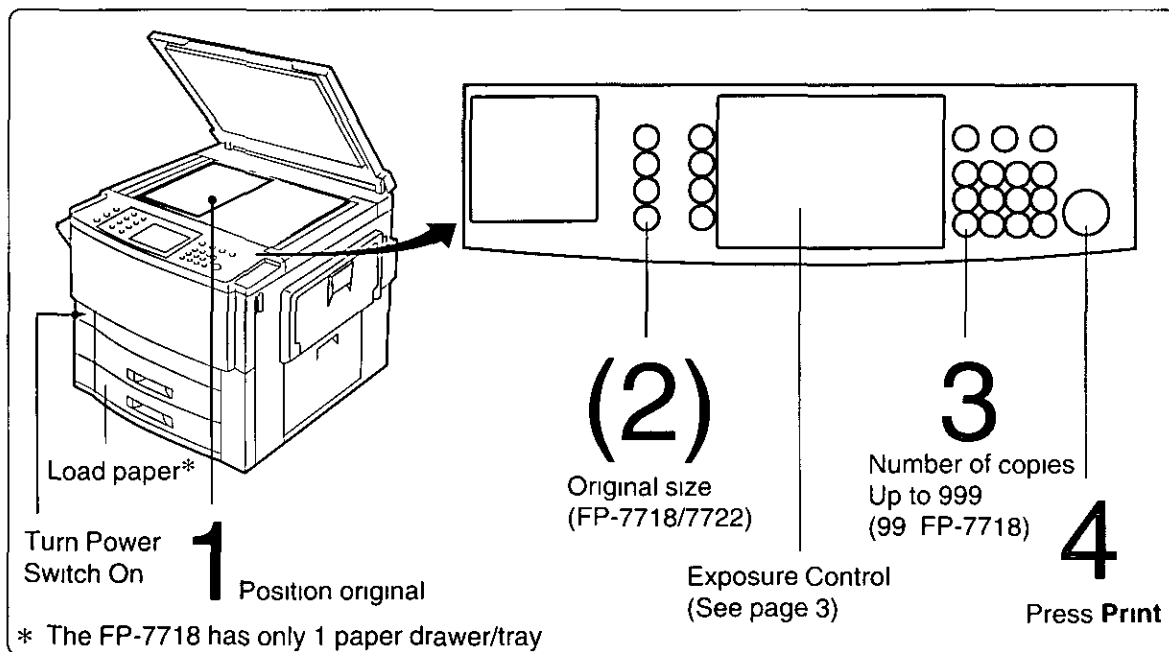

### ■ Position of the original

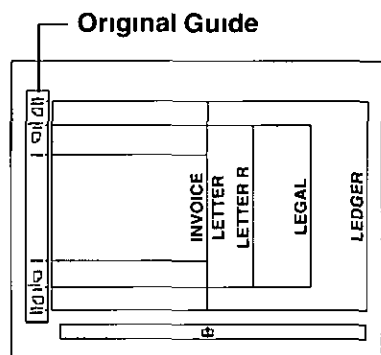

- Face Down on platen and in ADF (FA-A505)  
Face Up in i-ADF (FA-A888)
- If the original is not positioned properly, a portion of the original may not be copied
- For originals smaller than invoice size, align with center of left original guide and select invoice (FP-7728/7735)
- For originals smaller than invoice size, use invoice key (FP-7718/7722)

### ■ Energy Saver mode

The FP-7718/7722/7728/7735 has functions for power saving while the copier is not in use  
If you wish to use this feature, consult your key operator or service technician

	Power Consumption	Warm Up Time
Energy saver mode		
FP-7718/7722	Approximately 85 Wh	30 Seconds
FP-7728	Approximately 105 Wh	30 Seconds
FP-7735	Approximately 130 Wh	30 Seconds
Auto off mode		
FP-7718	Approximately 5 Wh	40 Seconds
FP-7722	Approximately 5 Wh	50 Seconds
FP-7728/7735	Approximately 5 Wh	70 Seconds

■ When manually selecting exposure control or original size:

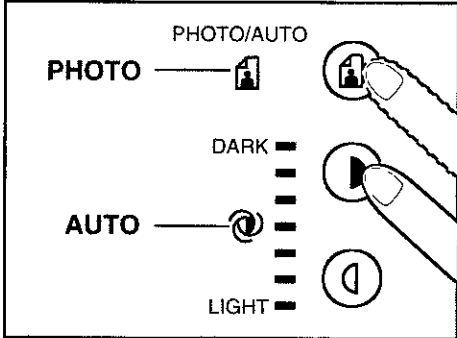

**Select exposure control**

- ① Press the Light key to copy colored background or Dark key for light image original etc ,
- ② Press the Photo/Auto Select key to copy photos and halftones

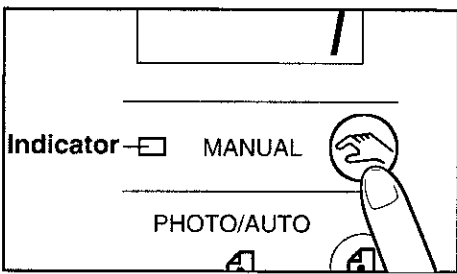

**Select original size**

- ① Press Manual key
  - The indicator lights up (Manual mode)
- ② Select original size with Original Size key

● **Benefits of Quantum™ Technology:**

The FP-7718/7722/7728/7735 features Quantum™ Technology which utilizes an advanced form of artificial intelligence to ensure optimal copy quality and performance under varying environmental conditions, from a wide range of originals

■ **Paper Drawer/Tray**

- ① The paper drawer/tray is designed to accommodate invoice, letter, letter R, legal and ledger size paper To change the paper size, consult your service technician for proper instructions (See page 22)
- ② The FP-7718 has only 1 paper drawer/tray

**NOTE**

- Remove stacked copies from the exit tray every 250 sheets
- When copying onto special paper, use the sheet bypass (Letterhead, mailing labels, transparencies, etc ,) (See page 16)

# Options

## Components

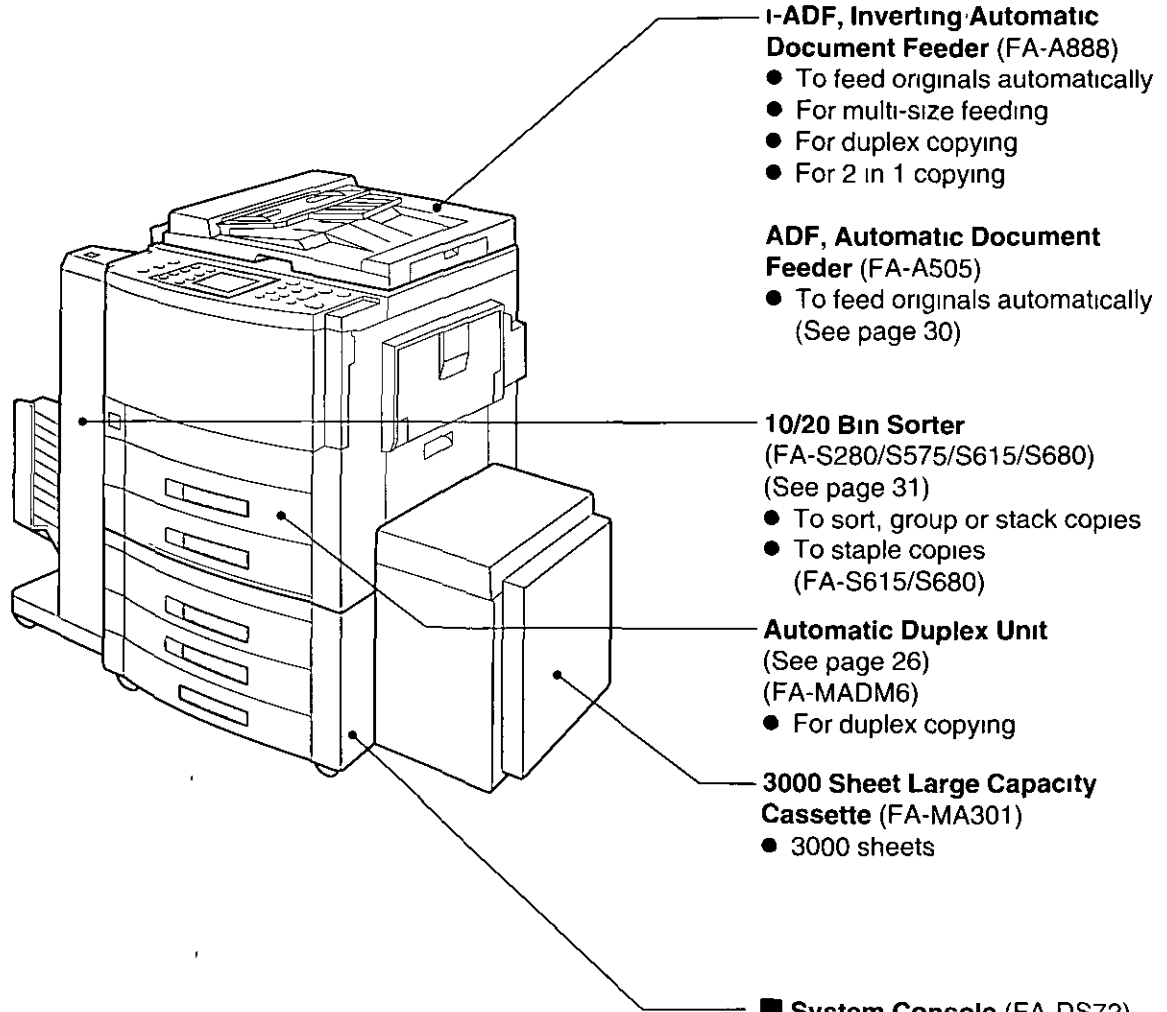

■ Commonality of optional accessories  
(The FP-7728/7735 with options)

	FP-7718	FP-7722	FP-7728	FP-7735
FA-A505	○	○	○	○
FA-A888	○	○	○	○
FA-S280	△	○	○	×
FA-S575	×	○	○	○
FA-S615	△	○	○	×
FA-S680	×	○	○	○
FA-MADM6	×	○	○	○
FA-MA301	×	×	○	○
FA-DS72	△	○	○	○

○ YES × NO

△ Combination use possible with mounting kit,  
consult your service technician

■ **System Console (FA-DS72)**

- To increase paper feed sources and capacity  
Storage Drawer × 1
- To increase the number of paper drawers, an optional accessory is needed Consult your service technician  
Upper/middle stage Paper drawer (FA-MA055)  
Lower stage Paper drawer and mounting kit

**The paper drawer/tray is designed to accommodate invoice, letter, letter R, legal and ledger size paper To change the paper size, consult your service technician for proper instructions (See page 22)**

# Table of Contents

## Before operating

Precautions		6
Components	■ Control Panel	9
	■ Special Effects Panel/Communications Monitor	10

## Making Copies

Common Features	■ Reduction or Enlargement Copying	12
	■ Zoom Copying	13
	■ Creative Features (Margin Shift Edge Book 2-Page Copy Mode)	14
	■ Using the Sheet Bypass	16
Creative Features	■ OHP Interleaving	17
	■ Copy Access Program	18
	■ Programming Copy Jobs	19
User Preset	■ User Preset 1	20
	■ Changing Paper Size, Skyshot Mode	22
	■ User Preset 2	24

## Options

■ ADU, Automatic Duplex Unit	26
■ i-ADF/ADF	28
■ Sorter	31

## Maintenance

Handling	■ Adding Paper	36
	■ Adding Toner	38
	■ Removing a Paper Misfeed	40
Checking	■ Troubleshooting	48

## Specifications

FP-7718/7722/7728/7735, FA-A505/A888	50
FA-S280/S575/S615/S680	51
FA-DS72, FA-MA301/MADM6	52

# Precautions

## Handling

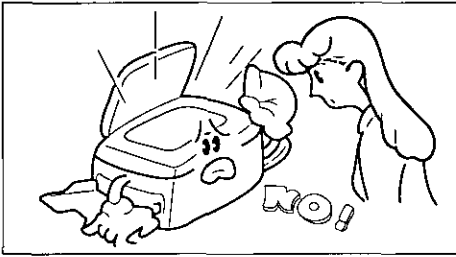

- Do not look directly at exposure lamp when copying

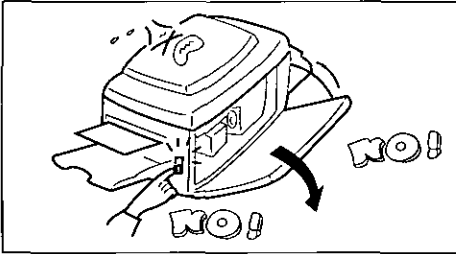

- Do not turn the power switch off or open the front panel during copying
- Do not drop paper clips or other metal objects into the copier

## Toner and Paper

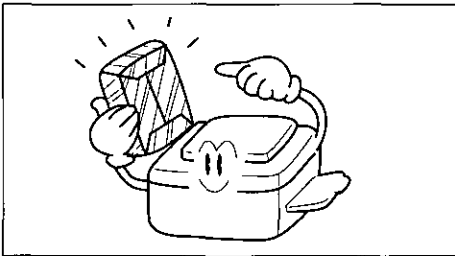

- Store toner, developer and paper in cool areas with low humidity
- High quality paper of 16 lbs - 24 lbs (15 – 30 lbs via sheet bypass) may be used
- For optimum performance, it is recommended that only Panasonic Brand supplies be used in the copier

## Ventilation

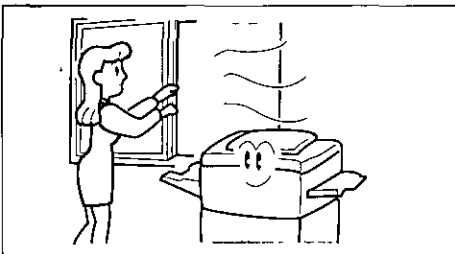

- The copier should be installed in a well-ventilated area, to minimize the ozone density in the air
- The FP-7718/7722/7728/7735 power consumption is 1.5 kW. A properly wired (with ground), dedicated, 15 A, 120 V AC outlet is required. Do not use an extension cord.

## Installation

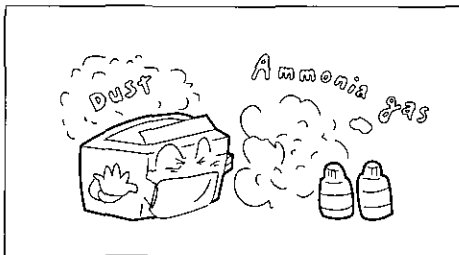
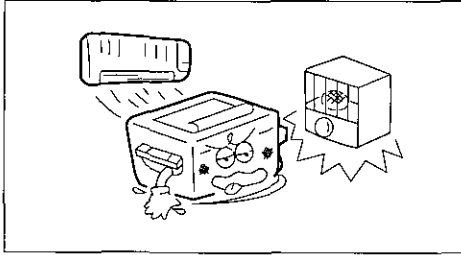

- The copier should not be installed in areas with the following conditions
- Extremely high or low temperature and humidity  
Ambient conditions  
Temperature 50°F – 86°F  
Relative humidity 30% – 80%
- Area where temperature and humidity can change rapidly
- Direct exposure to sunlight
- Directly in air conditioning flow
- In areas of high dust concentration
- In areas of poor ventilation
- In areas with chemical fume concentration
- In areas with extreme vibration
- With unstable or uneven conditions (floors, etc )

### For U.S.A.

This equipment has been tested and found to comply with the limits for a Class A digital device, pursuant to part 15 of the FCC Rules. These limits are designed to provide reasonable protection against harmful interference when the equipment is operated in a commercial environment. This equipment generates, uses, and can radiate radio frequency energy and, if not installed and used in accordance with the instruction manual, may cause harmful interference to radio communications. Operation of this equipment in a residential area is likely to cause harmful interference in which case the user will be required to correct the interference at his/her own expense.

Any unauthorized changes or modifications to this equipment would void the users authority to operate this device.

# Energy Star



The FP-7718, 7722, 7728, & 7735 copiers comply with Tier 2 of the Environmental Protection Agency's Energy Star Program. This voluntary program specifies certain energy consumption and usage standards for copiers. The FP-7718, 7722, 7728, & 7735 will automatically "power down" after a specified period of non-use. The use of these Energy Star compliant copiers will reduce energy consumption and ultimately benefit the environment.

The default functions can be adjusted depending on your office requirements. Please see your authorized Panasonic copier dealer for more details.



# Control Panel

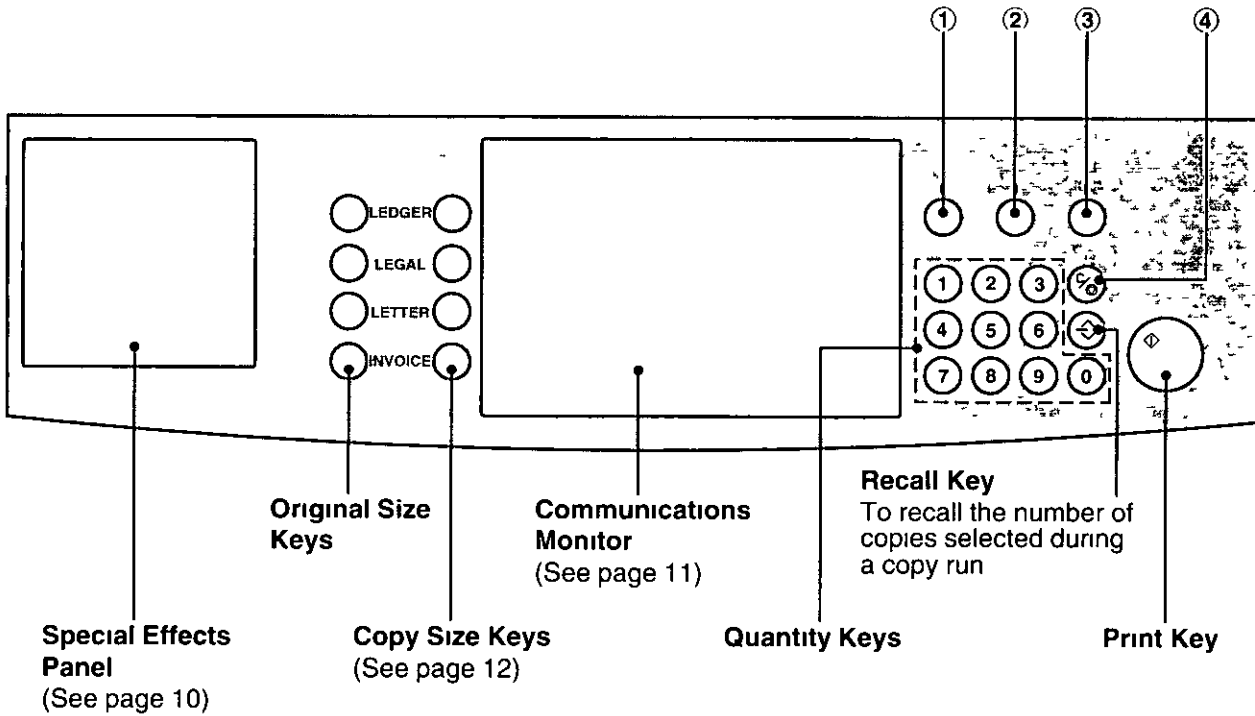

No	Contents	Function
①	Energy Saver Key	<ul style="list-style-type: none"> <li>● Press to select the energy saver mode while the copier is not in use</li> <li>● Press Energy Saver key again, to cancel and make copies</li> </ul>
②	Interrupt Key	<ul style="list-style-type: none"> <li>● Press <b>Interrupt</b> key, then indicator will light Make other copy job</li> <li>● Press <b>Interrupt</b> key again to continue original job</li> </ul>
③	Reset Key	Press to reset all features to initial power-on state
④	Clear/Stop Key	Press to stop copy run or clear copy count in display

# Components

## Special Effects Panel

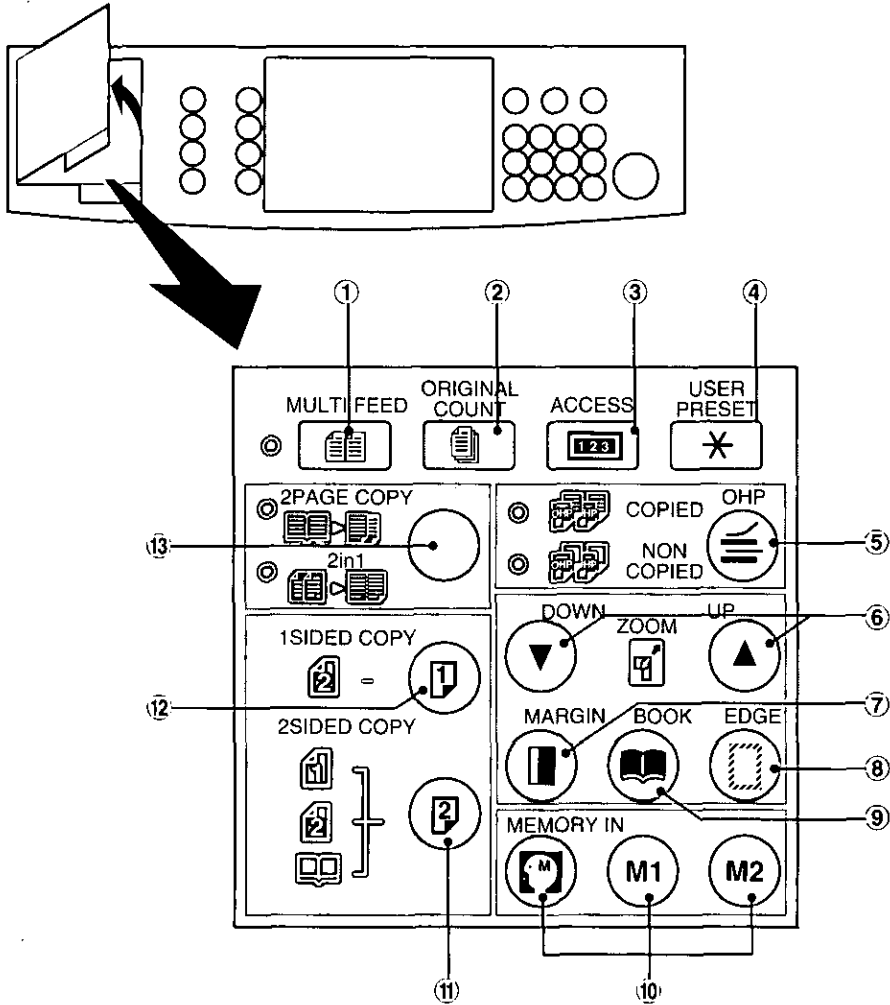

No	Keys	Refer to	No	Keys	Refer to
①	Multi-Size Feeding ● Using i-ADF	P.29	⑧	Edge Mode	P.14
②	Original Count (FP-7722/7728/7735) ● Using i-ADF and ADU 2 in 1 mode	P.26	⑨	Book Mode	P.15
③	Access	P.18	⑩	Memory In/Job programs	P.19
④	User Preset	P.20	⑪	Duplexing mode selection (FP-7722/7728/7735) ● Using ADU	P.26
⑤	OHP interleaving mode	P.17	⑫	2:1 Copy ● Using i-ADF	P.30
⑥	Zoom	P.13	⑬	2-Page copy/2 in 1 mode selection	P.15, 30
⑦	Margin Shift Mode	P.14			

# Communications Monitor

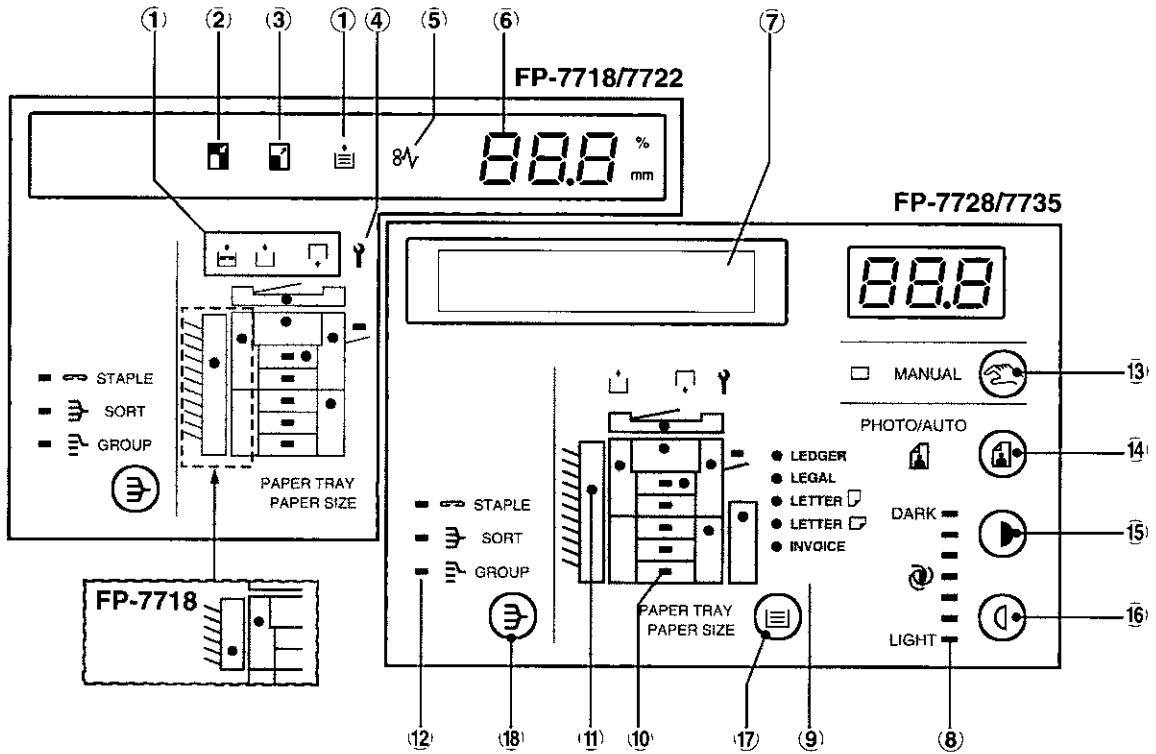

No	Indicator	Refer to	No	Indicator	Refer to
①	Adding Paper Toner Staple (FP-7718/7722) Replacing Waste Toner Bottle	P 36 P 38 P 33, 34 P 39	⑦	Message Display (FP-7728/7735) Indicates procedures, functions, maintenance, etc ,	—
②	Reduction	P 12	⑧	Exposure Indicator	P 3
③	Enlargement	P 12	⑨	Paper Size Indicator	—
④	Service Call Lights up when it's time for routine maintenance	—	⑩	Paper Drawer/Tray Indicator (-)	—
⑤	Paper Misfeed	P 40 - 47	⑪	Paper misfeed location (•)	P 40
⑥	Copy Count Display Indicates number of copies, zoom ratio and error code	—	⑫	Mode Select Indicator Staple Sort Sort Group	P 32

No	Keys	Refer to	No	Keys	Refer to
⑬	Manual Key	P 3	⑯	Exposure Control (LIGHT)	P 3
⑭	PHOTO/AUTO	P 3	⑰	Paper Drawer/Tray	—
⑮	Exposure Control (DARK)	P 3	⑱	Mode Select Key	P 32

# Reduction or Enlargement Copying

## When copying with preset ratios

■ There are 5 preset reduction and 4 preset enlargement modes.

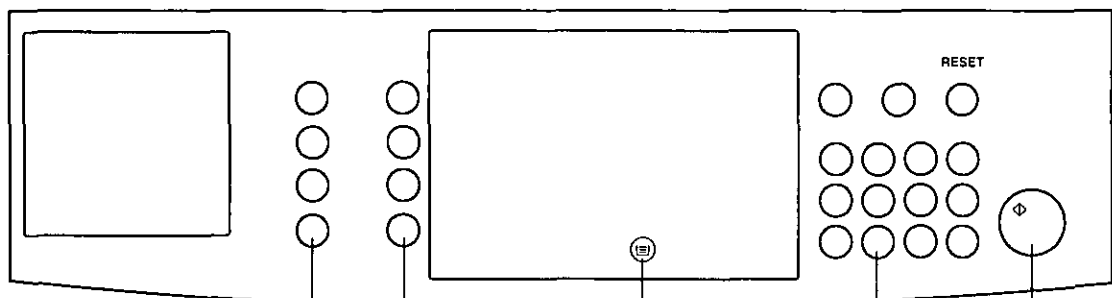

- 1 Position original
- (2) Original size (FP-7718/7722)
- 3 Select the copy size (Landscape for letter size)
- Paper Tray Key
- 4 Number of copies
- 5 Press Print

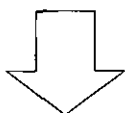

Example: Reduction

Original size → Copy size

LEDGER

→

LETTER

The correct ratio is automatically selected.

Original size (%)

Original size	Copy size			
	Ledger	Legal	Letter	Invoice
Ledger	100	77	65	50
Legal	121	100	79	61
Letter	129	100	100	65
Invoice	200	155	129	100

### ATTENTION

- Part of the image may be deleted if the direction of the original and copy paper do not correspond.
- If a different paper size is desired, press the Paper Drawer/Tray Select key. When Copy Size key is pressed, the ratio will return to preset position.

### NOTE

- To reset reduction or enlargement copying, press Reset key.

# Zoom Copying

## When copying with variable zoom ratios

- A zoom ratio can be selected from 50% to 200% in 1% increments.

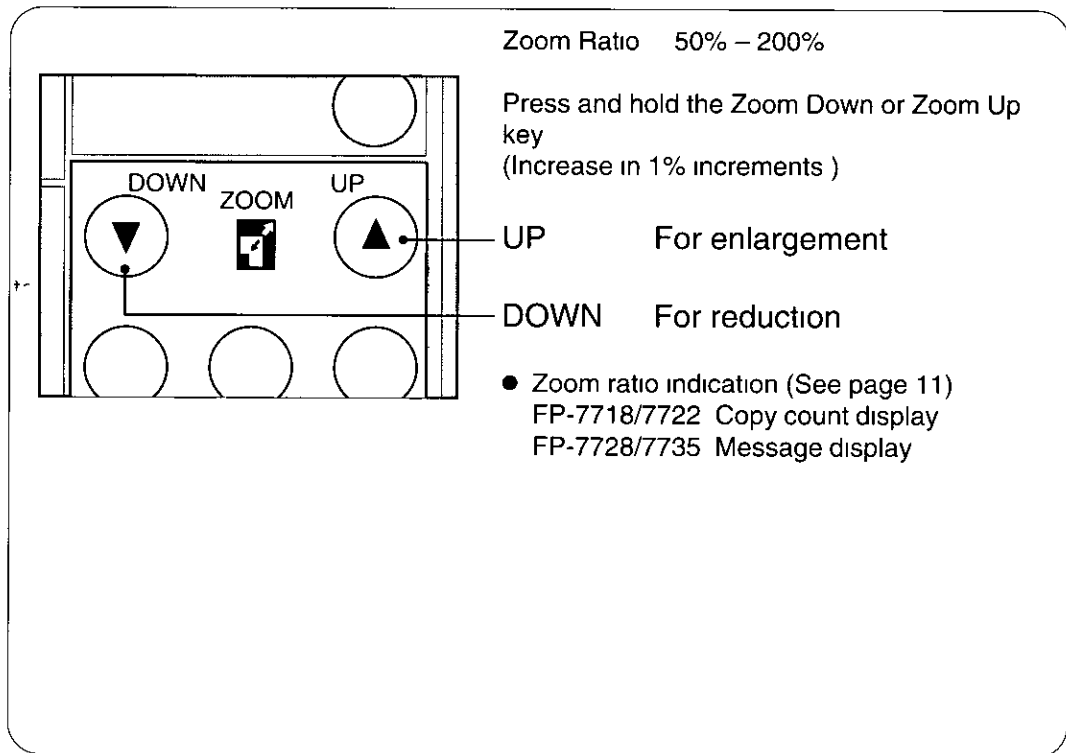
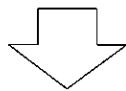
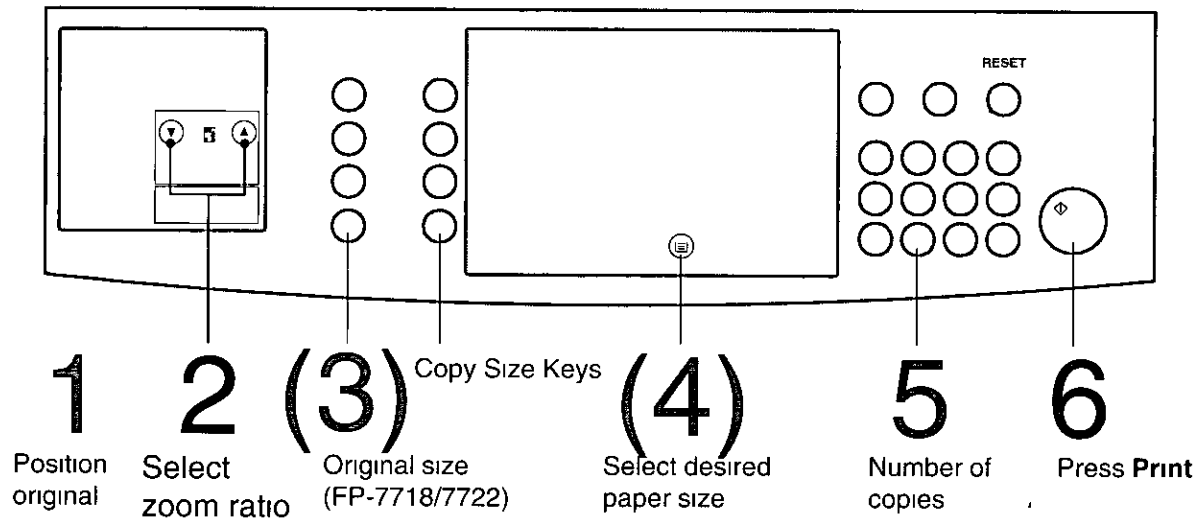

### ATTENTION

- If a different paper size is desired, press the Paper Drawer/Tray Select key  
When Copy Size key is pressed, the ratio will return to preset position

### NOTE

- To reset zoom copying, press Reset key

# Creative Features

## Margin/Edge

### Margin Shift Mode

Shifts image to right

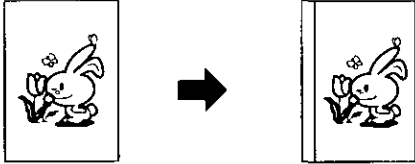

The margin is initially set at 10 mm  
Range can be set from 2.5 mm to 97.5 mm  
in 2.5 mm increments

### Edge Mode

Creates a blank edge

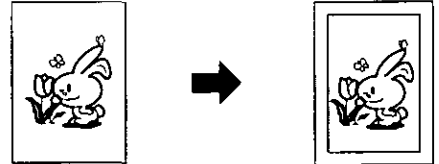

The edge width is initially set at 5.0 mm  
Range can be set from 5.0 mm to 95 mm  
in 5.0 mm increments

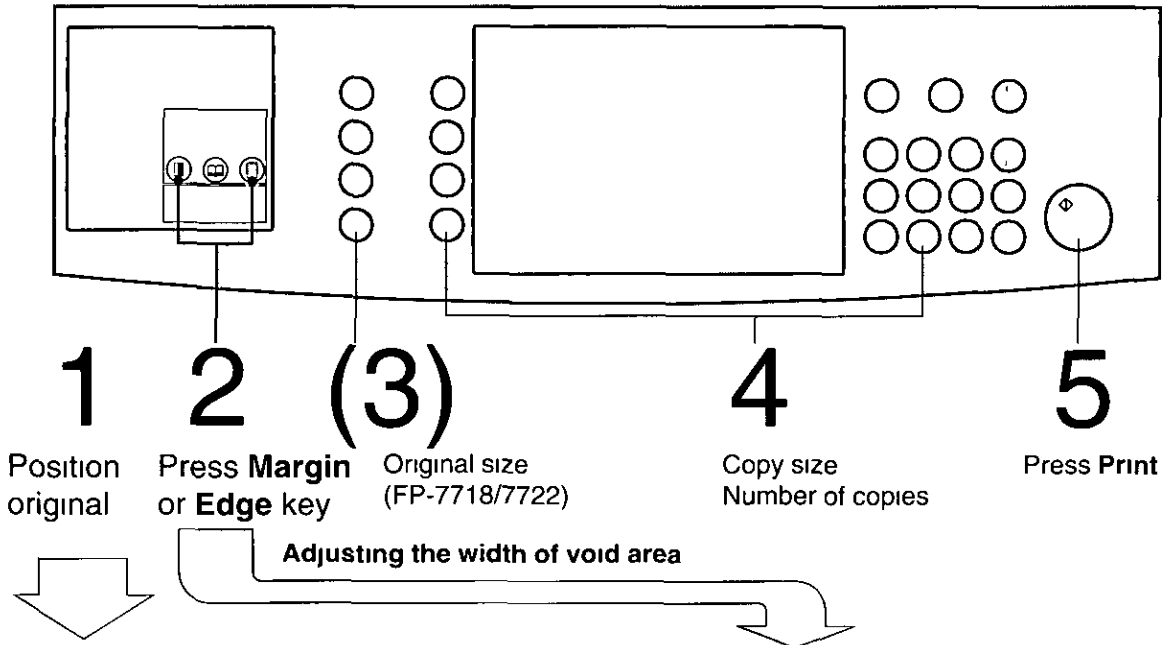

1 Position original

2 Press Margin or Edge key

(3) Original size (FP-7718/7722)

4 Copy size Number of copies

5 Press Print

Adjusting the width of void area

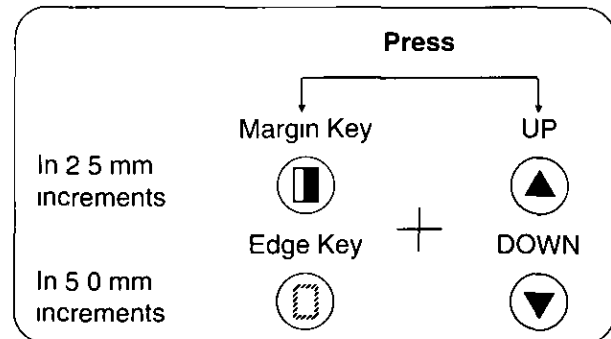
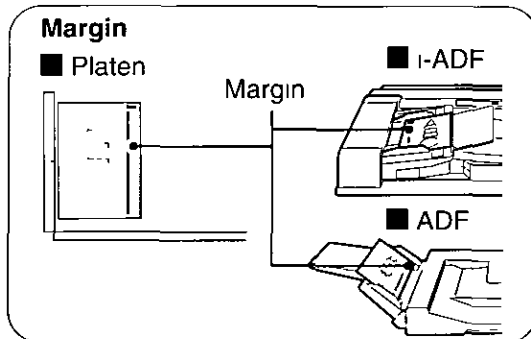

### NOTE

- If Margin shift mode cuts off right side of image, use Margin reduction mode (95%, 93% or 91%) to create a margin (See page 21)

# Book/2-Page Copy



## Book Mode

Eliminates dark inner binding shadows

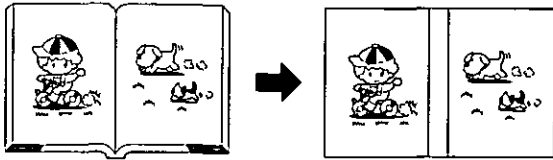

Book mode is initially set at 20 mm. Range can be set from 2.5 mm to 97.5 mm in 2.5 mm increments.



## 2-Page Copy Mode

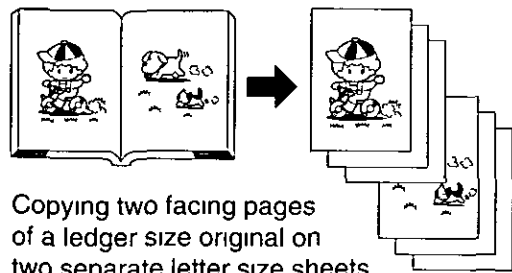

Copying two facing pages of a ledger size original on two separate letter size sheets.

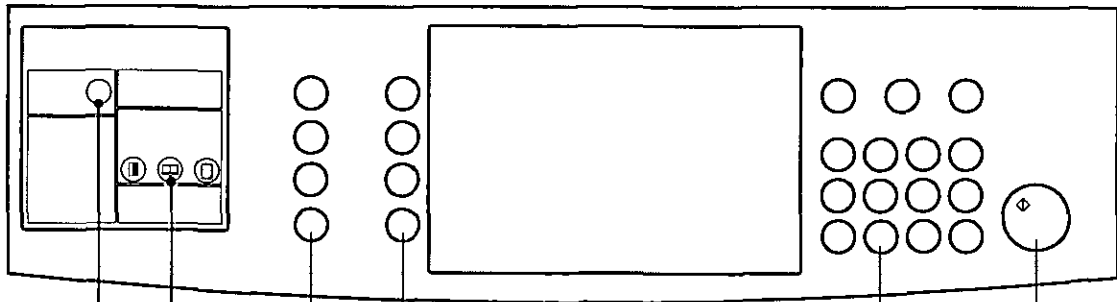

1 2 (3)(4)

Position original

Press **Book** or **2-Page Copy** key

Original size (FP-7718/7722)

Copy size (Reduction or Enlargement)

Number of copies

Press **Print**

Adjusting the width of void area (Book)

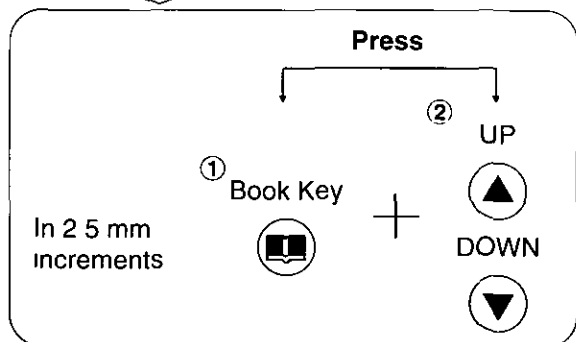
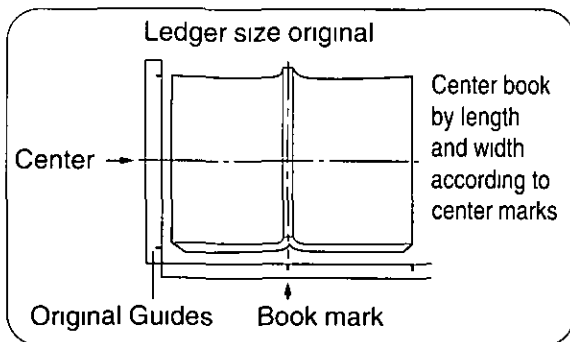

### NOTE

- Margin, edge and book modes  
When adjusting the width of void area, press and hold the Margin, Edge or Book key then press the Zoom Up or Zoom Down key
- To reset each mode, press the Edge, Margin, Book key again or Reset key

# Using the Sheet Bypass

**When copying on special paper, etc.**

- For 2-sided copying or to copy on letterhead, mailing labels, transparencies and odd-size paper, etc., or to use bypass as an additional paper source.

1

Position original

Select original size (FP-7718/7722)

2

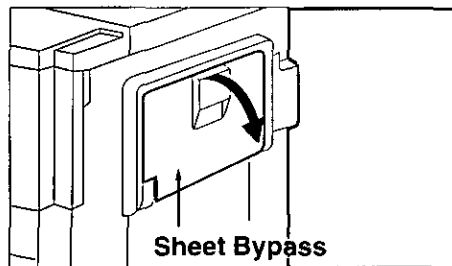

Open sheet bypass

3

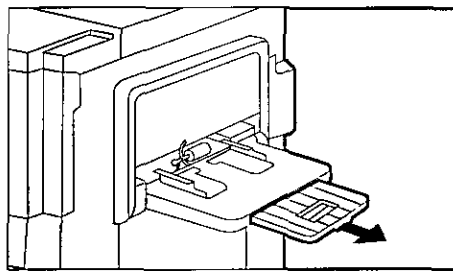

Pull out bypass tray until it stops

4

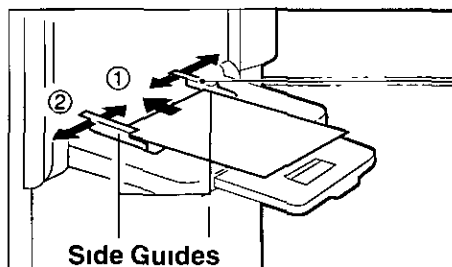

- ① Place approximately 50 sheets of paper

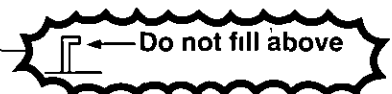

Insert the paper until it stops  
First copy side up

- ② Adjust the side guides  
Incorrect adjustment may cause paper to wrinkle, misfeed or skew

5

Press **Print**

## NOTE

- The bypass has priority over the paper drawers/trays. The copier automatically selects the sheet bypass when paper is placed in the empty bypass tray.
- Some types of mailing labels and transparency film may damage your machine. Please contact your service provider for advice regarding non-standard paper types.



# OHP interleaving

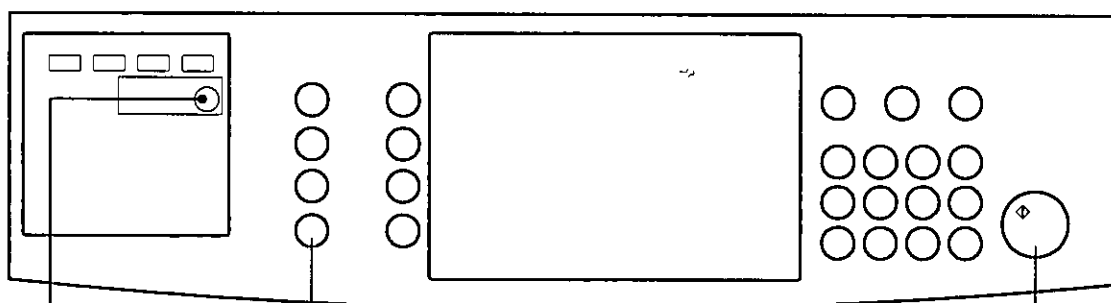
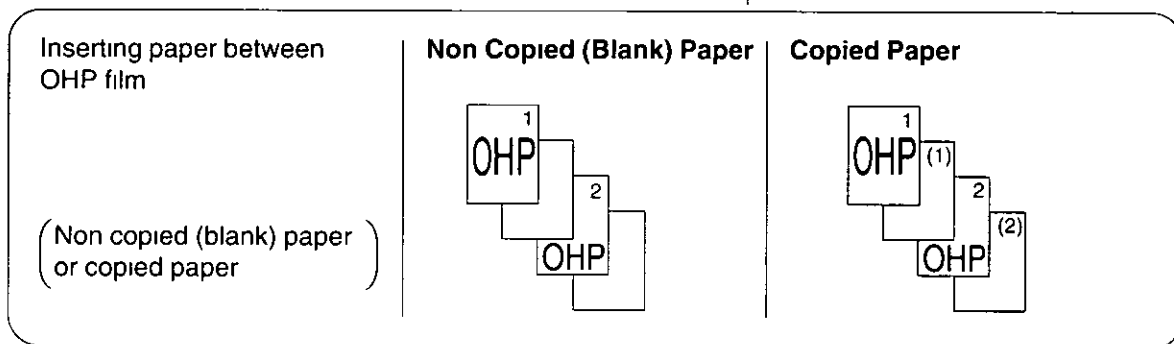

- 2** Select OHP interleaving mode
- 1** Place OHP (Sheet Bypass)
- 3** Position original
- 4** Original size (FP-7718/7722)
- 6** Press Print

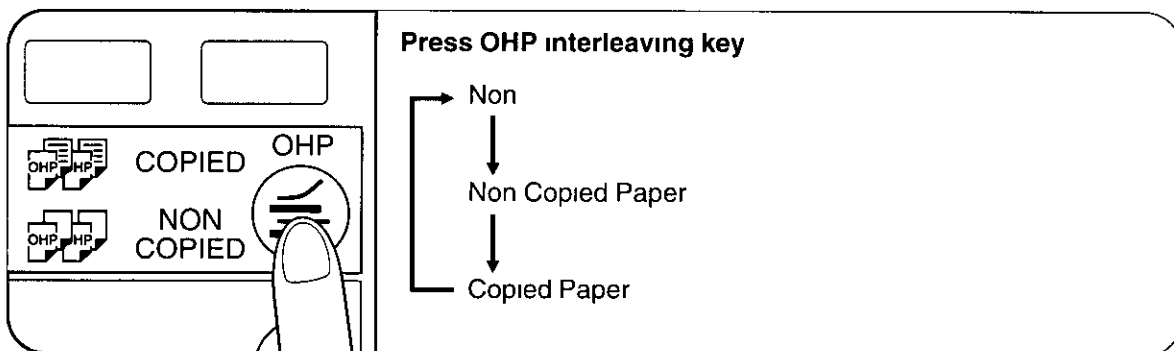
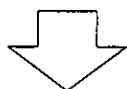

# Copy Access Program

- This feature allows the monitoring of up to 100 (50: FP-7718/7722) individual departments, etc., when activated U0 will appear in the copy count display.

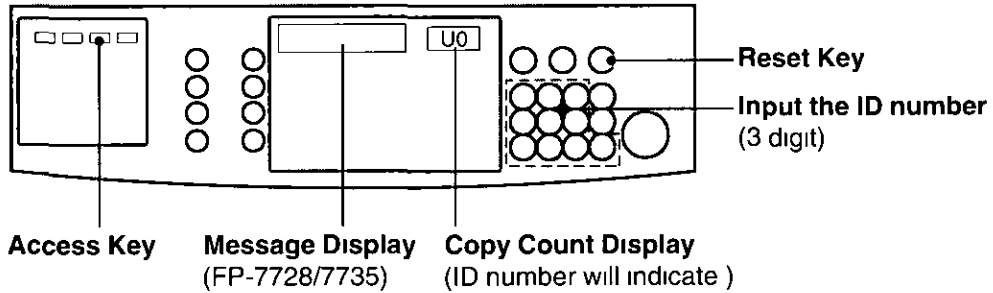

## Making a copy.

- ① Input the ID number
- ② Make copy
- ③ Press Reset key to return to U0

## Check total copy usage of all departments.

- ① Press Access key
- ② Check display

Example 5,678 copies

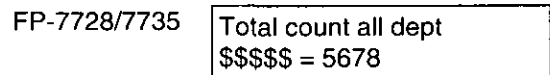
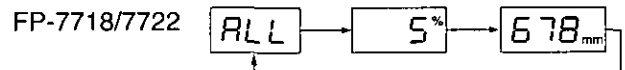

- ③ Press Reset key to return to U0

## Check total copy usage of a specific department.

- ① Input the ID number
- ② Press Access key

Example Department code=1  
1,234 copies

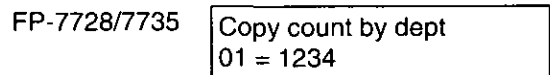
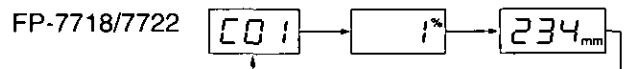

- ③ Press Reset key to return to U0

### NOTE

- The copy access program must be set-up by the service technician

# Programming Copy Jobs

- Two copy jobs can be programmed in memory (M1 or M2) for recall at a later time.

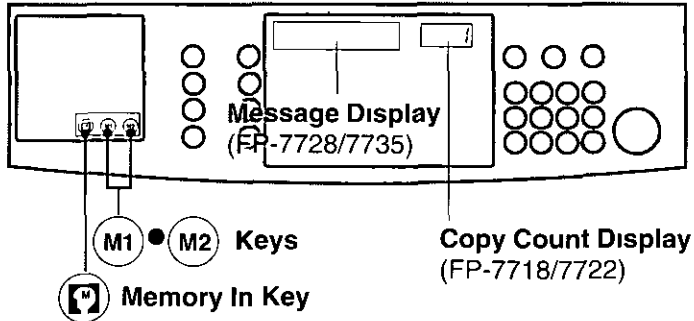



## To store a job in memory

- Set up the copy job to be stored in memory



-  **Memory In Key**

FP-7718/7722 The copy count display will flash

FP-7728/7735 Ready to program  
select Mem #

-  **M1** or  **M2**

## To recall a job stored in memory

-  **M1** or  **M2**

The job stored in each memory location can be changed if necessary

- Press **Print**

### NOTE

- When using the skyshot mode (M1 and M2 are turned ON), job memory cannot be used
- Job memory mode will not be deleted even if power switch is turned off
- When storing a new job, the previously stored job will automatically be deleted and the current job stored in its place

# User Preset 1

■ User Preset modes can change the initial copy mode, if necessary.

## 1. Operation

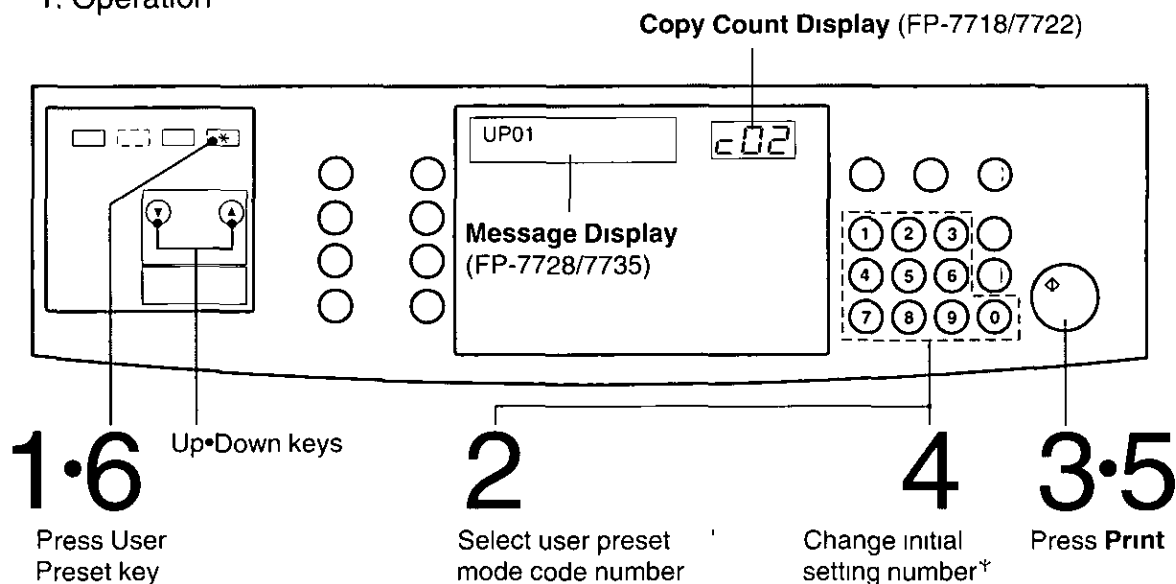

## 2 Contents

Code	Item	Function	Initial setting
UP00 or c00	Paper size ● Sets the paper size of each paper drawer	(0) Letter R (1) Legal (2) Letter (3) Ledger (4) Invoice	Copier 3 System console Consult service technician
UP01	Paper size priority ● Specifies the paper size of most frequent usage	(0) Letter (1) Letter R (2) Legal (3) Ledger (4) Invoice	0
UP02	Margin value default ● Selects the margin shift value	(0) 5 mm (1) 10 mm (2) 15 mm (3) 20 mm	1
UP03	Edge value default ● Selects the edge width	(0) 5 mm (1) 10 mm (2) 15 mm (3) 20 mm	0
UP04	Book value default ● Selects the book void width	(0) 15 mm (1) 20 mm (2) 25 mm (3) 30 mm	1

### NOTE

\* To change initial setting number, zoom (Up•Down) keys are also available

- Check selected code number with message display (FP-7728/7735) or copy count display (FP-7718/7722)
- Each code number is indicated as c00, c01, c02 , on the FP-7718/7722 copy count display

Code	Item	Function	Initial setting
UP05	Margin reduction ratio ● Selects the reduction ratio in margin mode	(0) Non (100%) (1) 95% (2) 93% (3) 91%	0
UP06	Sorter mode default ● Determines the most frequent usage mode	(0) Nonsort (1) Sort (2) Staple sort (3) Group	0
UP07	Duplex mode default ● Determines the most frequent usage mode	(0) No (1) [1] → [2] (2) [2] → [2] (3) Book → [2]	0
UP08	2 in 1 copy ratio ● Selects whether to copy full size or reduction in the 2 in 1 mode	(0) Full size (1) Reduction	1
UP09	Auto edge mode default ● Selects whether or not to disable Auto Edge Deletion <sup>1</sup>	(0) OFF (1) ON	1
UP10	Skyshot mode default ● Enables or disables the use of skyshot mode	(0) OFF (1) M1, ON (2) M2, ON (3) M1, M2 ON	0
UP11	Manual add toner ● Allows the addition of toner as determined by the operator	(0) OFF (1) ON Toner is rapidly added after entering the number (1) and pressing Print key	—
UP12 to 18	(Reserved)		
UP19	Set key operator code ● Input key operator ID number		

**NOTE****\* Auto Edge Deletion**

To copy from the platen with the original cover or i-ADF open. Normally, this makes a copy with a solid (black) area around the original if the original is smaller than the copy paper. This mode eliminates the solid area automatically.

- Skyshot mode (UP10 or c10) disables the use of the other job run memory

# User Preset 1

## Example: Changing Paper Size

- The paper drawer/trays are designed to accommodate invoice, letter, letter R, legal and ledger size paper. To change the paper size, consult your service technician for proper instructions.

Perform following steps as shown below after any locking screws have been removed

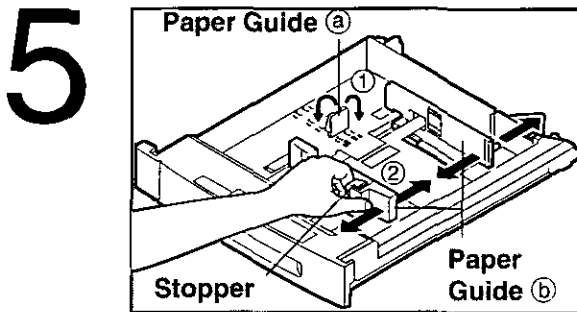
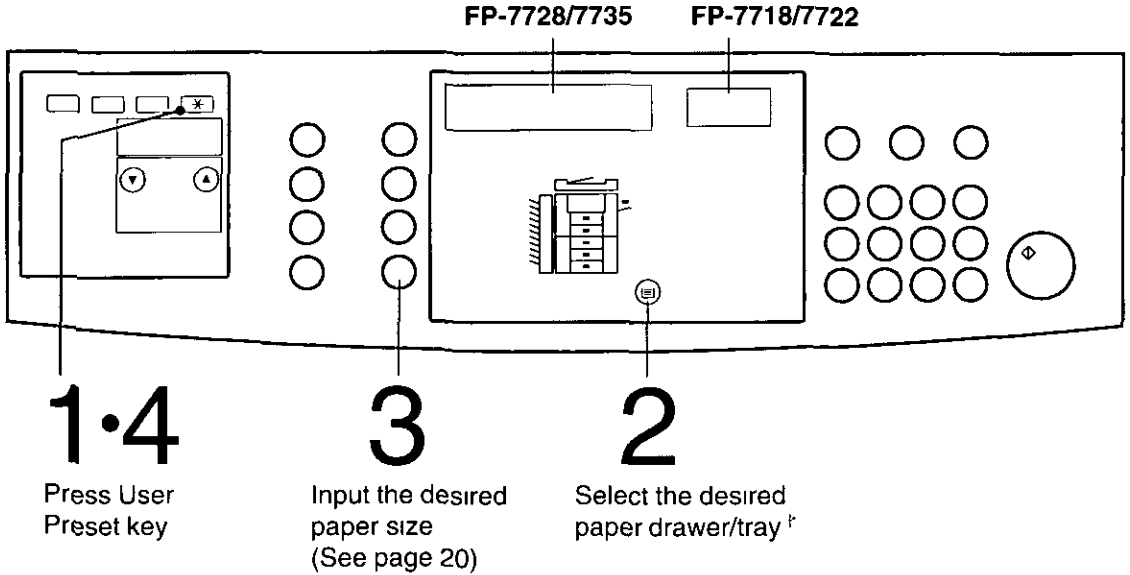

Pull out the desired paper drawer/tray

- ① Adjust paper guide (a) to paper length
- ② Adjust paper guide (b) to paper width  
Squeeze the stopper to move the paper guide (b) to the desired paper size

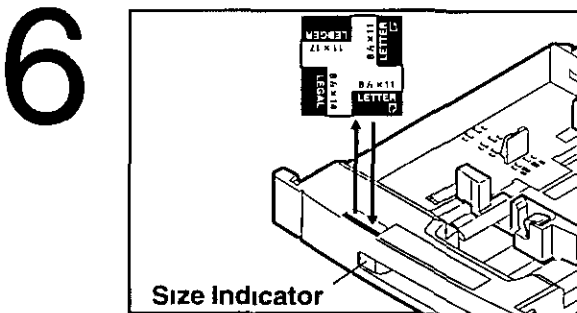

Change the paper size indicator

Take out and re-insert the indicator so the correct paper size is shown (Invoice size is on the back side)

### NOTE

\* If the paper drawer is not installed or is not inserted completely, the paper size indication will not appear

## Skyshot Mode

- By setting the check size (or other original smaller than letter size) in the user preset mode, copying from small originals is possible without dark areas around the image.

Setting of Skyshot mode by key operator

- ① Code No UP10 Input Function number 1, 2 or 3 (See page 21)
- ② Code No UP19 Input key operator ID number (See page 21)
- ③ Code No UP32 Input a size (M1) (See page 25)
- ④ Code No UP33 Input another size (M2) if necessary (See page 25)

### ■ Operation

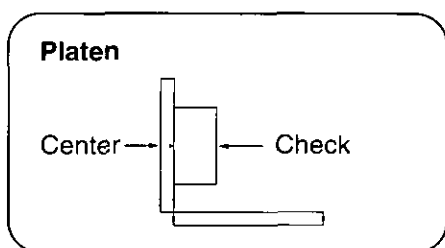

1

Position original

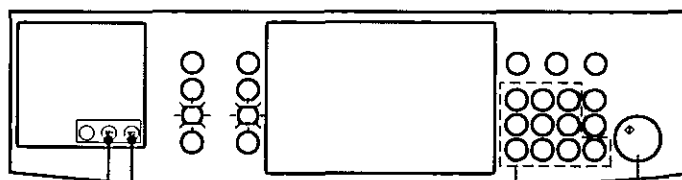

Select M1 or M2  
(Letter size keys  
will light)

Number of  
copies

Press Print

#### NOTE

- If changing the sizes in memory, perform above steps ② to ④
- To reset Skyshot mode, press Reset key

# User Preset 2

## For Key Operator

- The UP20 – UP34 initial settings can be changed after entering the Key Operator ID Number.

### 1 Operation

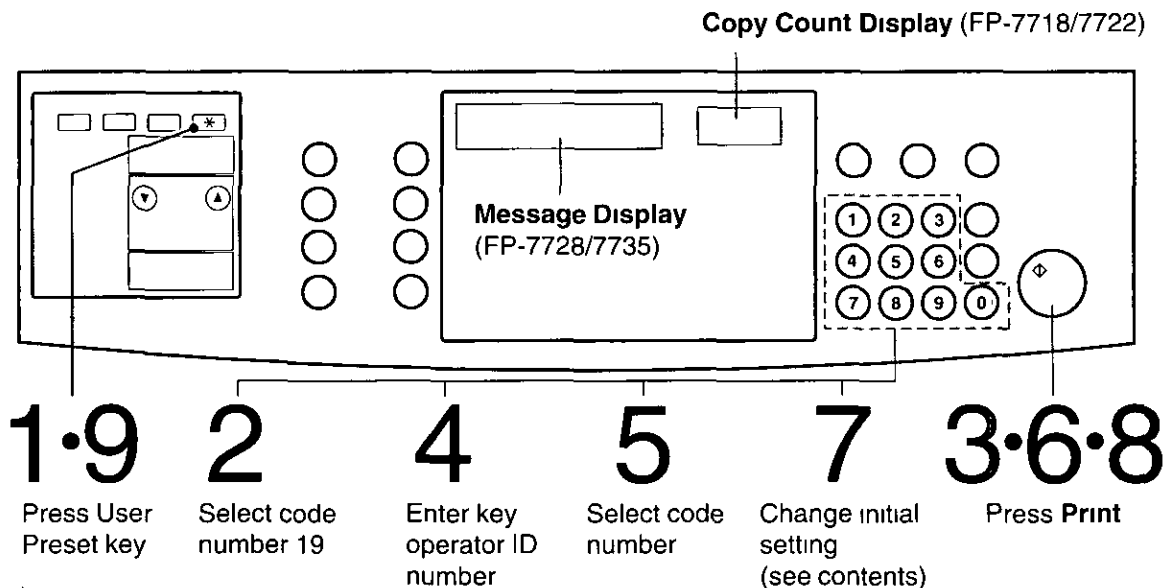

### 2 Contents

Code	Item	Function	Initial setting
UP20	Auto reset time ● Selects the reset time	(0) Non (1) 45 seconds (2) 1 minute (3) 2 minutes	2
UP21	Energy saver time ● Selects the energy saver time	(0) 15 minutes (1) 30 minutes (2) 60 minutes (3) 1 5 hours (4) 2 hours (5) 3 hours (6) 4 hours	0
UP22	Auto off time ● Selects the Auto off time	(0) No (1) 30 minutes (2) 60minutes (3) 1 5 hours (4) 3 hours (5) 4 hours	2 1 (FP-7718)
UP23	Exposure default ● Determines whether to use Auto Exposure	(0) Non (1) Auto (2) Manual	2

#### NOTE

- Check selected code number, key operator ID number and initial setting with message display (FP-7728/7735) or copy count display (FP-7718/7722)



Code	Item	Function	Initial setting
UP24	Language default ● Selects the message language of the display (For FP-7728/7735)	(0) Japanese (1) English (2) German (3) French (4) Italian (5) Spanish (6) Swedish (7) Finnish (8) Dutch (9) Portugal	1
UP25	Special paper tray 1 ● Sets the paper drawer for special (color) paper	(0) Non (1) Copier upper stage (2) Copier lower stage (3) System console upper stage (4) System console middle stage (5) System console lower stage (6) LCC (7) Sheet bypass	0
UP26	Special paper tray 2	same as UP25	0
UP27 to 30	(Reserved)		
UP31	Maximum copy setting ● Determines whether to limit number of copies	(0) Non (n) Sets Input limit number of copies (1 to 99) and press Print	0
UP32	M1, size ● Input a size in memory 1 for frequent usage size (X Width Y Length) mm	Step 1 Input size Y and press Print Step 2 Input size X and press Print	160 × 70 (Y) (X)
UP33	M2, size ● Input another size in memory 2 for frequent usage	same as UP32	220 × 95 (Y) (X)
UP34	Department counter mode ● Checks or changes all or specified departments for copy usage, copy limit and ID number*	Select a function number (1, 2 or 3) and press Print then change initial setting (1) Copy Count (2) Copy limit (3) Code number	Consult your service technician

\* FP-7718/7722 = 50 ID numbers  
FP-7728/7735 = 100 ID numbers

## NOTE

- Direction of check

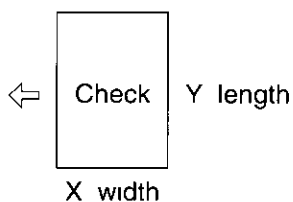

# Automatic Duplex Unit

## FA-MADM6 (FP-7722/7728/7735)

■ **1 → 2 Copy**  
From Copier Platen & i-ADF  
(From Copier Platen & i-ADF/ADF)

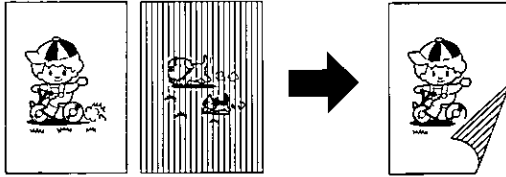

■ **2 → 2 Copy**  
From 2-sided originals to 2-sided copies  
(Using i-ADF)

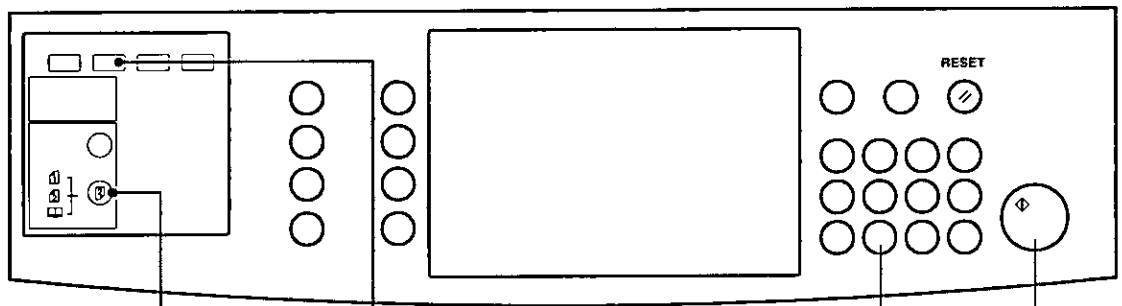
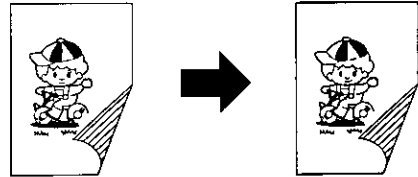

- 1** Position originals
- 2** Select Duplexing mode 1 or 2
- (3)** Press Original Count key (1 → 2 copy/using ADF) Return originals to ADF
- 4** Number of copies Up to 50
- 5** Press **Print**

**i-ADF**

**Face-Up**

ADF/Platen  
After copies are made, position the next original Press Print

- **1 → 2 copy from Platen**  
When making 2 sided copies from odd number originals, the last copy remains in the ADU Press Reset to feed last copy out of the ADU

**NOTE**

- **Automatic margin shift mode**  
If the margin shift mode is selected, copies of the back side of each original are automatically shifted to the right (See page 14)

\* If you are using the FA-888 to make 2-sided copies from 1-sided originals, place originals face-up in the original feed tray and press the Original Count key Then, reload originals and press Print

■ **Book → 2 Copy**

From book originals to 2-sided copies  
Ledger size originals only

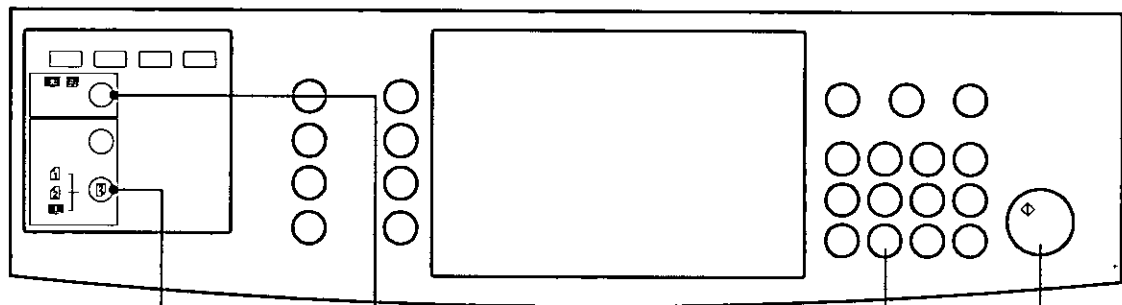
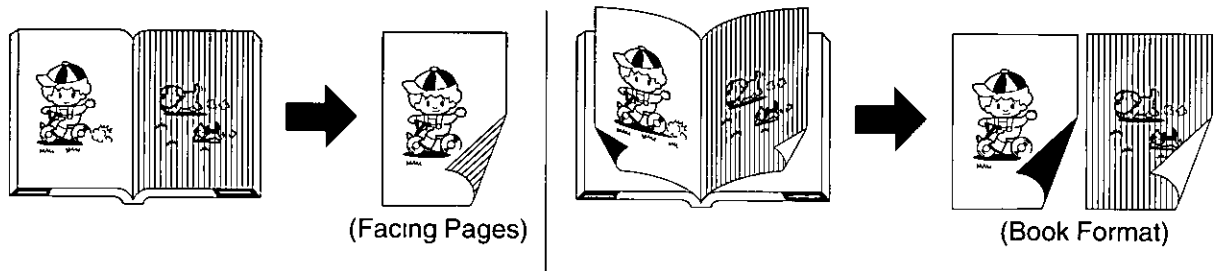

- 1** Position original
- 2** Select Duplexing mode (Ⓛ)
- (3)** Select 2-Page Copy mode (Ⓛ-Ⓛ) (Book Format only)
- 4** Number of copies (Up to 50)
- 5** Press Print

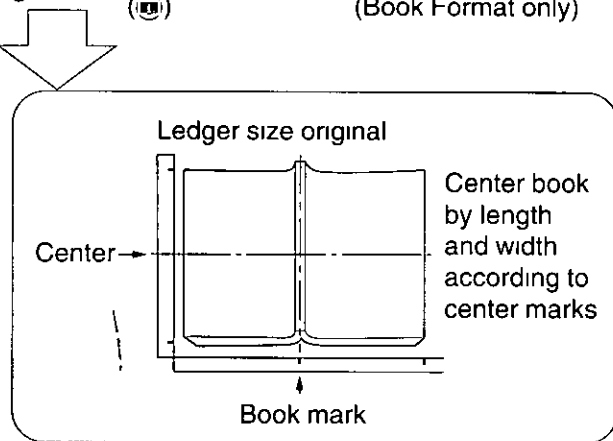

- Make copies from last page in Facing pages and Book Format mode

**NOTE**

- Press the reset key to feed out last copy existing in the ADU (Automatic Duplex Unit)

# Automatic Document Feeder

## i-ADF (FA-A888)/ADF (FA-A505)

### 1 Features

- ① Automatic original feeding
  - The i-ADF/ADF tray can hold up to 50 originals of 20 lbs paper (30 originals/legal, ledger)  
It can accommodate originals from invoice to ledger size
  - Automatic original size detection
- ② Duplexing (FA-A888)  
The i-ADF allows you to perform two different types of duplexing automatically
- ③ Multi-size feeding (FA-A888)  
Different size originals to be copied full size (1 1) or same size (See page 29)

Originals	Copies		
	Full size	Reduction	Enlargement
Legal Letter R	Legal Letter R	Letter R/Invoice Letter R/Invoice	Ledger Ledger
Ledger Letter	Ledger Letter	Letter R Letter	—

- ④ 2 1 Copy (FA-A888)
  - 2-sided original to 1-sided copies (See page 30)
- ⑤ 2 in 1 copy (FA-A888)  
To make a 1-sided copy (full size or reduction), from two 1-sided originals side-by-side (See page 30)

### 2 Components

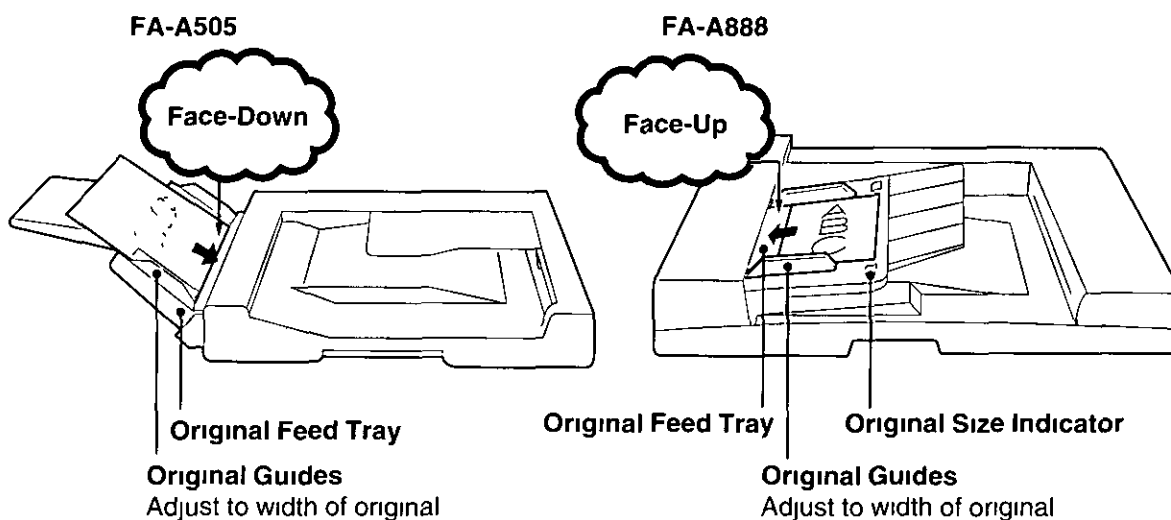

### 3 Usage

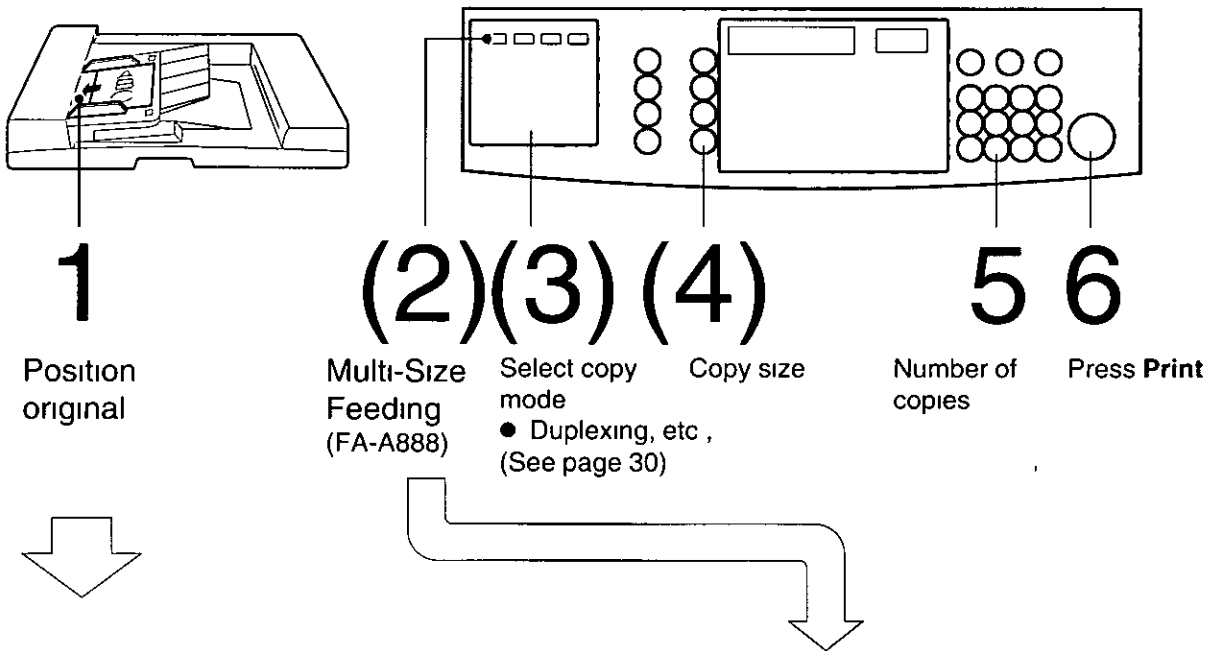

#### Inappropriate originals

- Paper with a smooth surface such as art and coated papers
- Transparencies
- Paste-ups
- Originals with a lead edge that is "creased", "folded", "punched" or "glued"
- Pressure sensitive or carbon backed papers
- Paper with excessive curl
- Stapled originals

- Press the Multi-Size Feeding key  
Different size originals to be copied full size (1 1) or same size

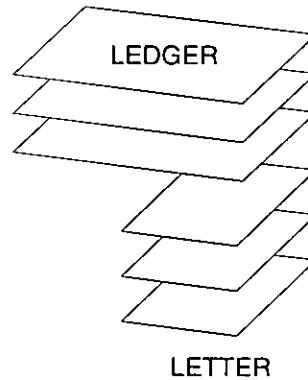

#### NOTE

- If you use the multi-size feed function on the i-ADF, make sure that the correct size paper is loaded in the copier before placing originals into the i-ADF

# Automatic Document Feeder

## i-ADF (FA-A888)

### 4 Creative Features

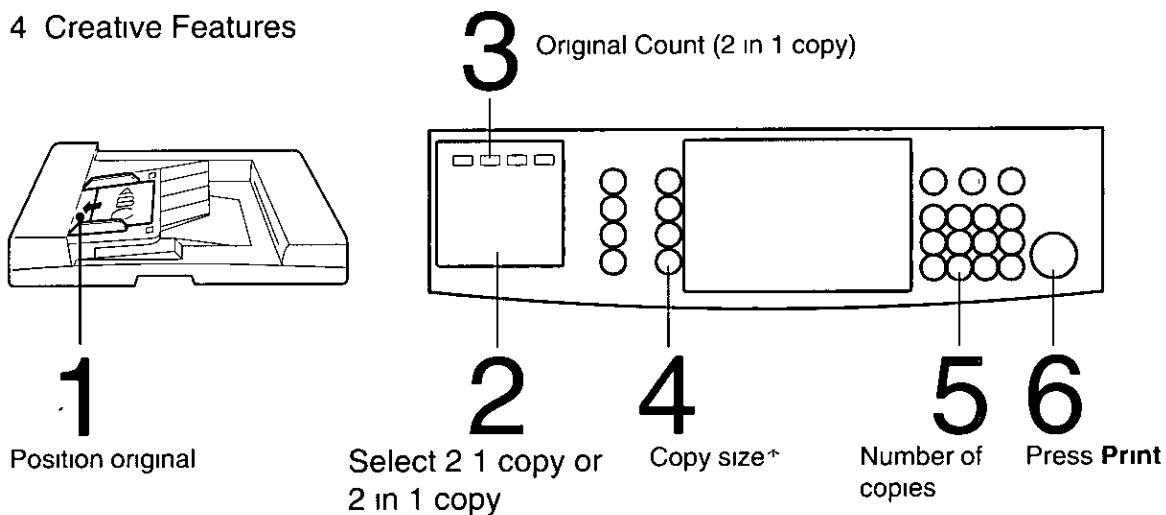

#### 2:1 Copy

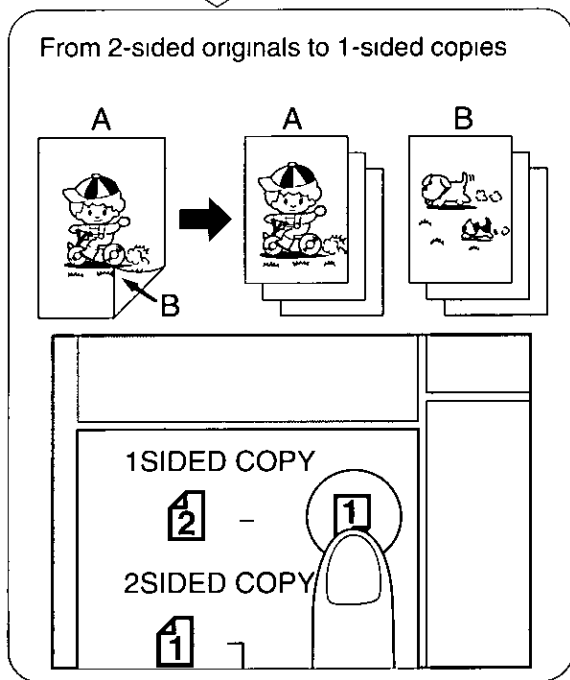

#### 2 in 1 copy

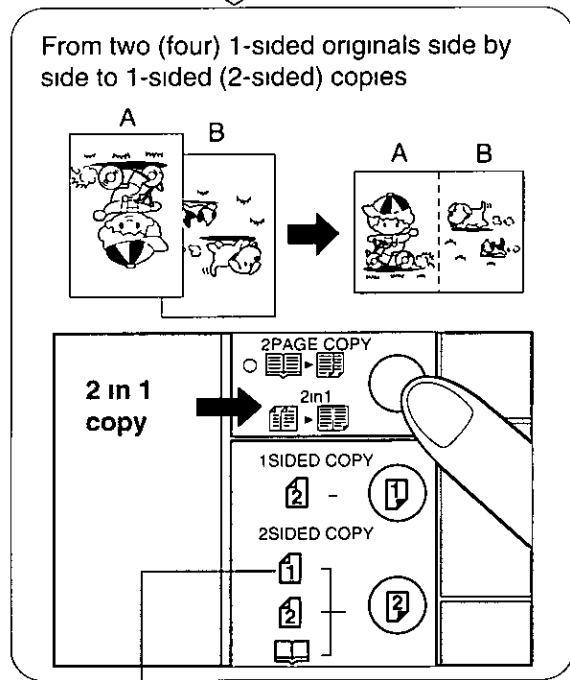

When making one 2-sided copy from four 1-sided originals, Select **1** → **2** copy mode and press Original Count key

**NOTE**

\* 2 in 1 copy  
For reduction or enlargement copy only

# Sorter

## 10 Bin Sorter (FA-S280/S615), 20 Bin Sorter (FA-S575/S680)

### 1 Components

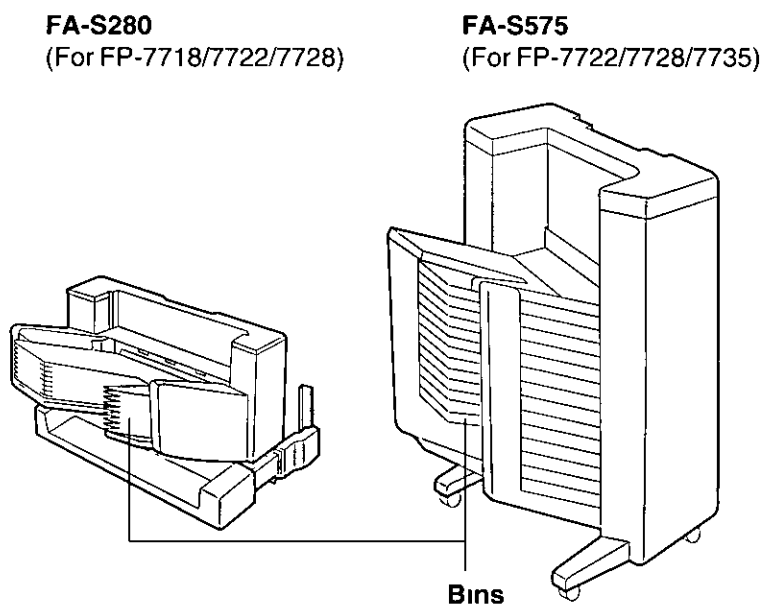

**FA-S680**  
(For FP-7722/7728/7735)

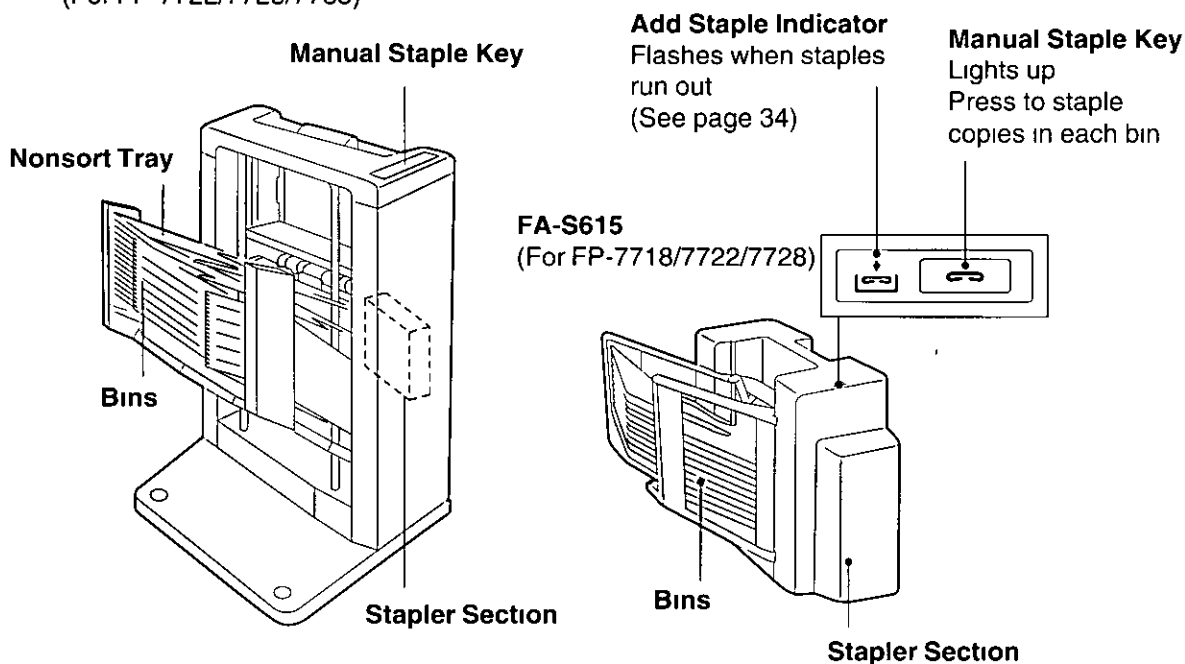

**NOTE**

**oF**

When the overflow **oF** indicator appears on the copy count display, remove excess copies from the bins, then press Mode Select key to reset

# Sorter

## 10 Bin Sorter (FA-S280/S615), 20 Bin Sorter (FA-S575/S680)

### 2. Usage

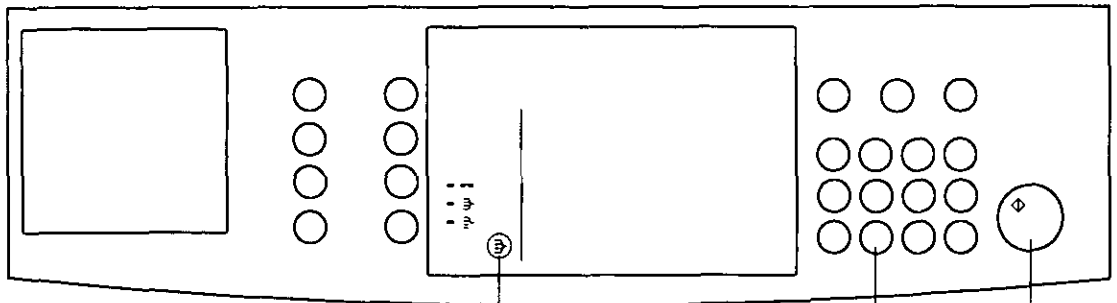

- 1** Position original
- 2** Select operating modes (Press Mode Select key)
- 3** Number of copies
- 4** Press Print

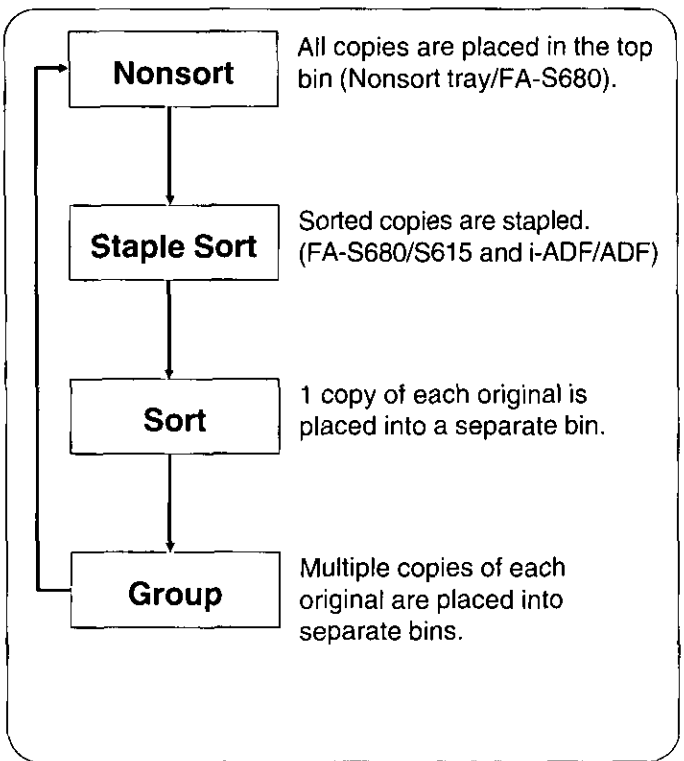
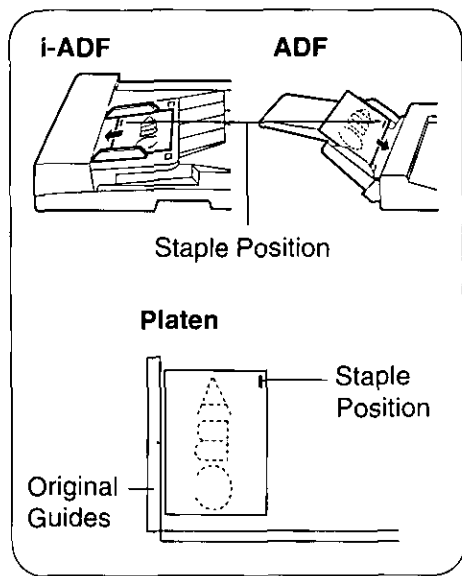

**NOTE**

- To manually staple copies (FA-S615/S680)
  - ① When using platen, the copies will not be stapled automatically, press Manual Staple key after copying is complete. (See page 31)
  - ② Size: Invoice to Ledger.  
Number of copies: Up to 50 sheets, 20 lbs. (20 sheets: FA-S615)



3 When adding staples

FP-7718/7722

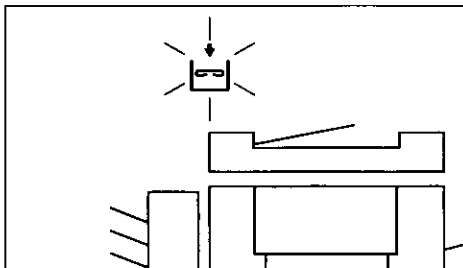

When the staple cartridge is empty,

- ① The indicator will light (FP-7718/7722)
- ② The message will appear (FP-7728/7735)

Add staples

1

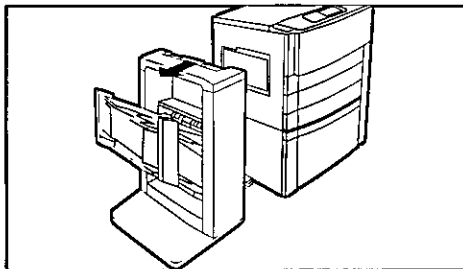

Pull sorter towards the left slowly until it stops

2

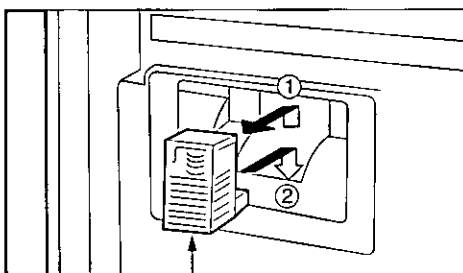

Staple Cartridge

- ① Take out empty staple cartridge
- ② Install the new cartridge  
Do not touch or move the staples
- ③ Re-insert sorter

3

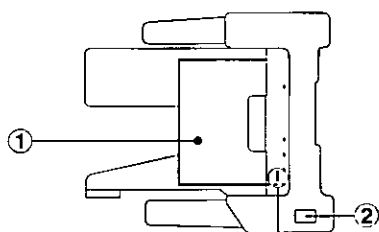

Staple Position

Check operations

- ① Place some letter size paper into stack tray
- ② Press the Manual Staple key and check staple operation

NOTE

- Order staple cartridges through your servicing dealer

ATTENTION

- When staples are jammed, call service

# Sorter

## FA-S615

### 3 When adding staples

1

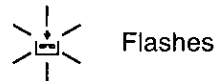
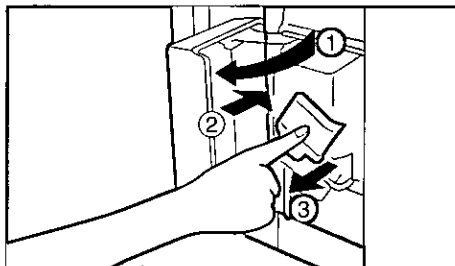

- ① Open stapler cover
- ② Push the stapler unit
- ③ Pull the stapler unit until it stops

2

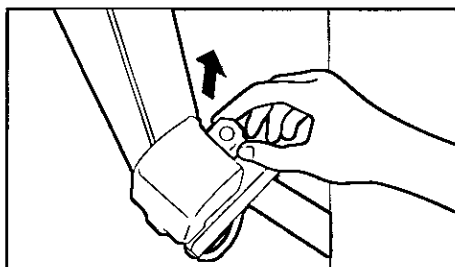

Take out empty staple cartridge

3

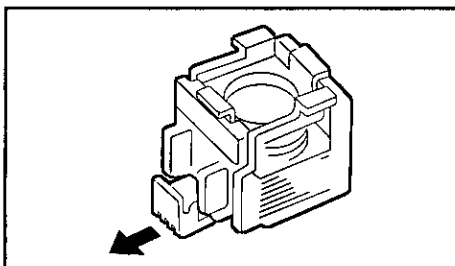

Prepare new staple cartridge  
(Consumable\*)

Remove black staple cover

4

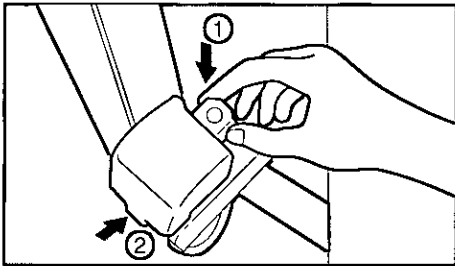

- ① Insert staple cartridge until it clicks
- ② Push the stapler unit until it stops
- ③ Close the stapler cover

5

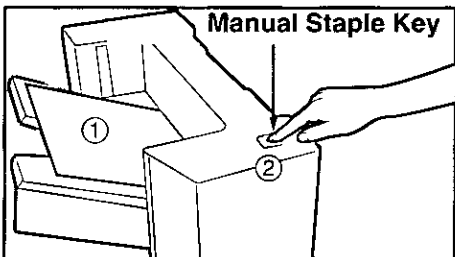

Check operations

- ① Place some letter size paper into the top bin
- ② Press the Manual Staple key and check staple operation

**NOTE**

\* Order staple cartridges through your servicing dealer

For FA-S615

- Two spare cartridges can be stocked inside of stapler cover

## 5 When staples are jammed

# 1

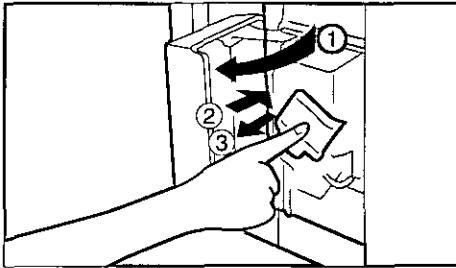

- ① Open stapler cover
- ② Push the stapler unit
- ③ Pull the stapler unit until it stops

# 2

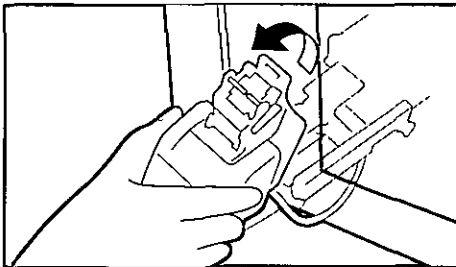

**Check stapling section and follow next steps.**

Lift up stapler unit

# 3

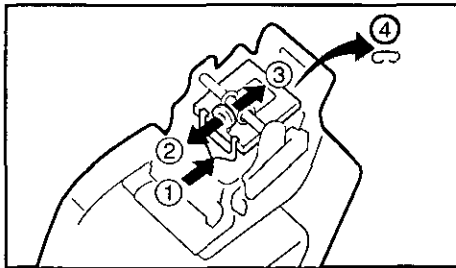

- ① Press the plastic stopper
- ② Pull the metal tab
- ③ Push the metal tab
- ④ Take out jammed staples

# 4

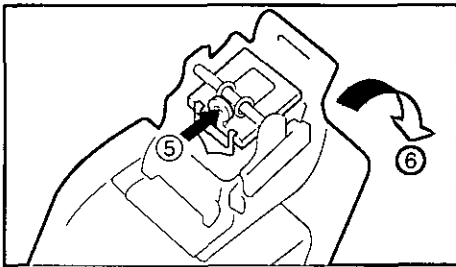

- ⑤ Push the metal tab until it clicks
- ⑥ Swing down the stapler unit to its original position

# 5

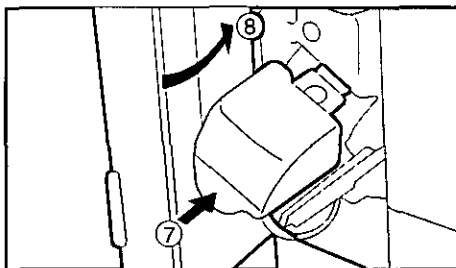

- ⑦ Push the stapler unit until it stops
- ⑧ Close the stapler cover

# Adding Paper

 (FP-7718/7722)/Add paper (FP-7728/7735)

## ■ 550 Sheet Paper Tray

1

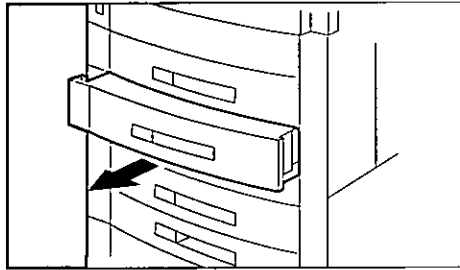

Pull paper drawer/tray out of copier

- The FP-7718 has only 1 paper drawer/tray

2

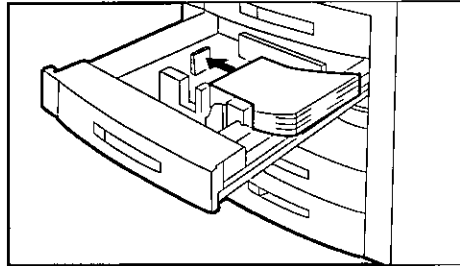

Place paper into paper drawer/tray

For better feeding, remove any wrinkled or torn sheets

To change paper size of the paper drawer/tray, see page 22

3

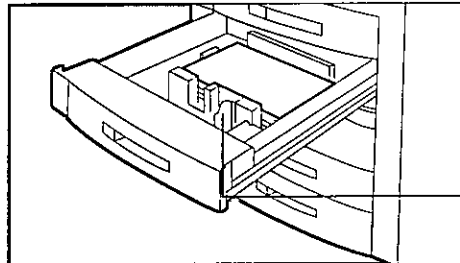

Make sure paper is not loaded above overfill indicator located in the paper drawer/tray

Overfill Indicator

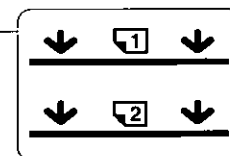

← 1-sided copy

2-sided copy<sup>1</sup>

4

Push paper drawer/tray back into copier

### ATTENTION

\* When making 2-sided copies without an automatic duplex unit, place the copies face-up in the paper drawer/tray to the 2-sided overfill indicator

- When the staple sorter is used  
Some papers may not be suitable for stapling. Please consult your service technician if you are unsure about the type of paper you are using

## ■ 3000 Sheet Large Capacity Cassette (LCC)

1

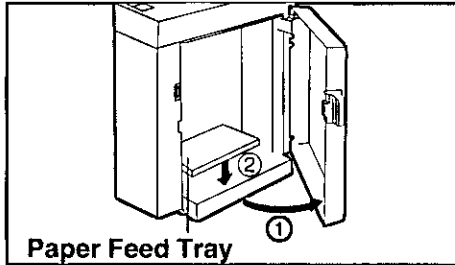

- ① Open the door
- ② The paper feed tray will go down

**Do not touch the tray while it is moving**

2

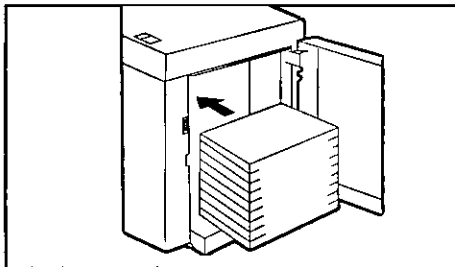

Place paper into paper drawer/tray

After tray stops, place paper neatly on to tray  
Letter size only (portrait)

3

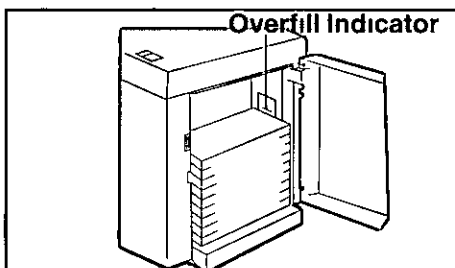

Do not fill above red line

Up to 3000 sheets, 20 lbs

4

Close the door



# Adding Toner (U13)

1

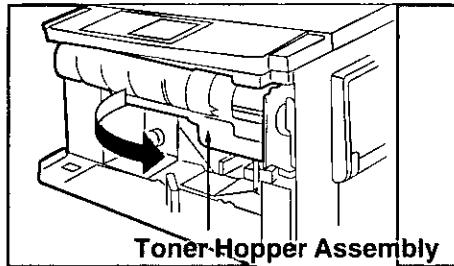

Open front panel

Turn toner hopper assembly

2

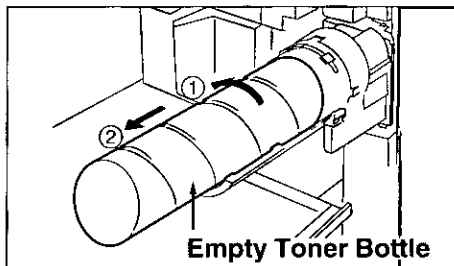

- ① Turn empty toner bottle until it stops
- ② Slide empty toner bottle towards you and remove

3

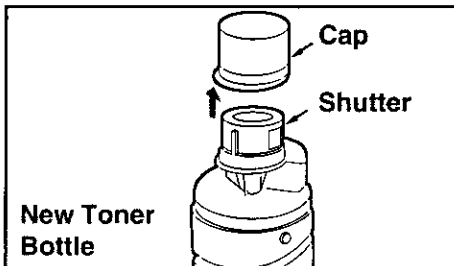

Shake well before using  
10–15 times until the toner inside is  
evenly distributed

Remove the cap from the bottle

**Do not turn the shutter**

4

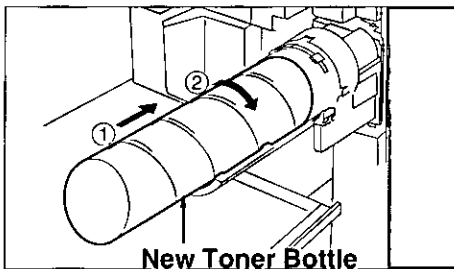

- ① Insert new toner bottle to the hopper assembly
- ② Turn the bottle until it stops, and arrows are aligned

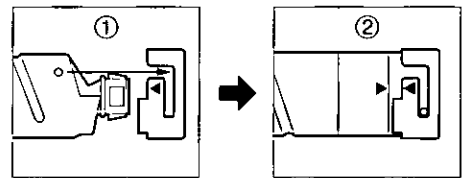

5

Close front panel

## ATTENTION

- For optimum copy quality use the recommended Panasonic toner. Store toner in a cool dark place. Do not unseal toner before use. Use it as fast as possible after unsealing.

# Replacing the Waste Toner Bottle (U14)

1

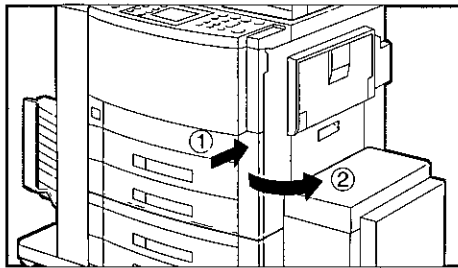

Open waste toner bottle cover

2

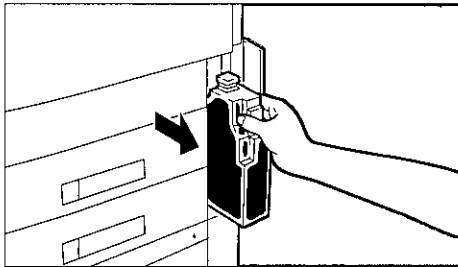

Slowly pull waste toner bottle straight out

Do not squeeze the bottle

3

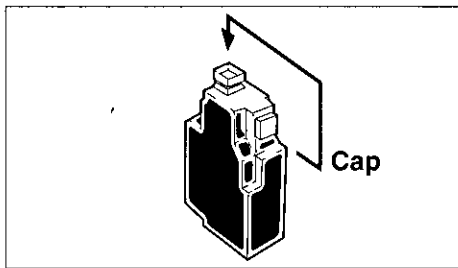

Close bottle with cap

4

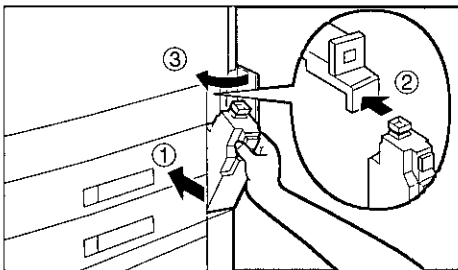

Install new bottle

Do not insert the bottle from the top

5

Close waste toner bottle cover

## ATTENTION

- Do not use toner in waste toner bottle



# Removing a paper misfeed

⚡ (FP-7718/7722)/Remove misfed paper (FP-7728/7735)

- When a paper misfeed has occurred, the misfeed indicator and misfeed position(s) will indicate on the communications monitor.

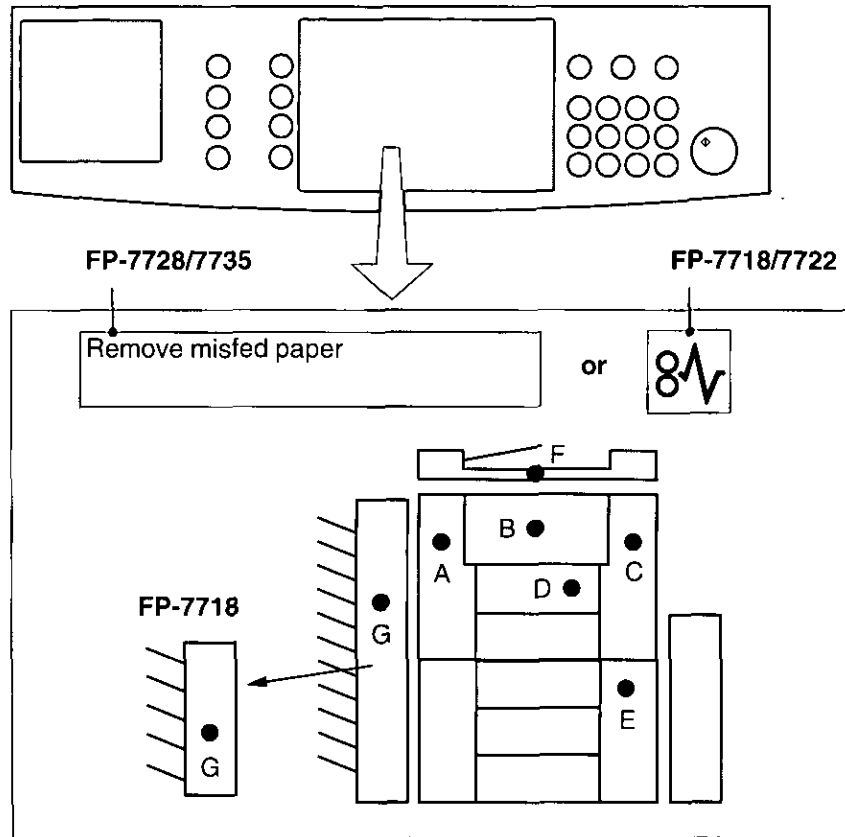

## ● Paper Misfeed Positions

<p><b>Copier or System Console</b></p>	<p>A: Paper Exit Area (See page 41)            B: Paper Transport Area (See page 42)            C: Paper Entry Area (See page 42)            LCC, Large Capacity Cassette (See page 44)            D: Automatic Duplex Unit (See page 43)            For FP-7722/7728/7735            E: System Console (See page 44)</p>
<p><b>ADF i-ADF</b></p>	<p>F: ADF/i-ADF (See page 45, 46)</p>
<p><b>Sorter</b></p>	<p>G: 10/20 Bin Sorter (See page 47)</p>



## ■ Paper Exit Area

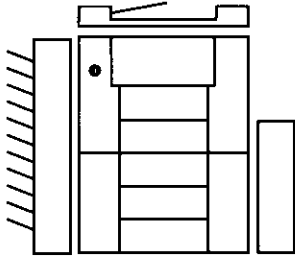

1

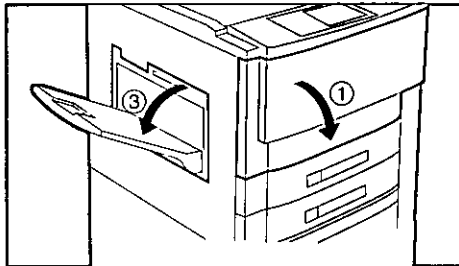

- ① Open front panel
- ② Move the sorter to the left if installed  
(See page 47)
- ③ Open exit cover

2

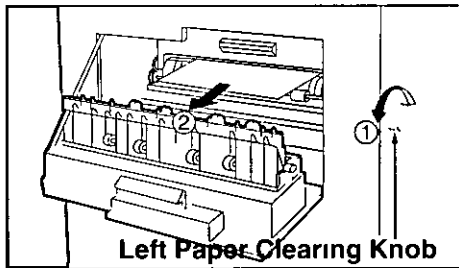

- ① Turn left paper clearing knob
- ② Remove misfed paper

3

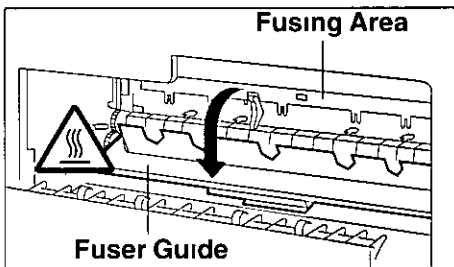

**Caution** this fuser area may be hot

- ① Open the fuser guide
- ② Check that no misfed paper is remaining
- ③ Close the fuser guide

4

- ① Close exit cover
- ② Close front panel  
Slide the sorter against the copier

### ATTENTION

- The fusing area may be hot, so use caution when removing misfed paper
- The front panel must be opened prior to opening the exit cover

# Removing a paper misfeed

8√ (FP-7718/7722)/Remove misfed paper (FP-7728/7735)

## ■ Paper Transport Area/Paper Entry Area

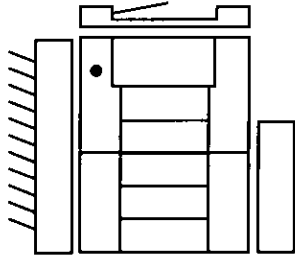

1

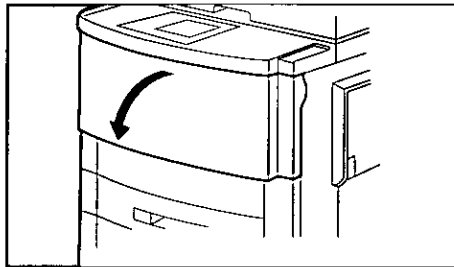

Open front panel

2

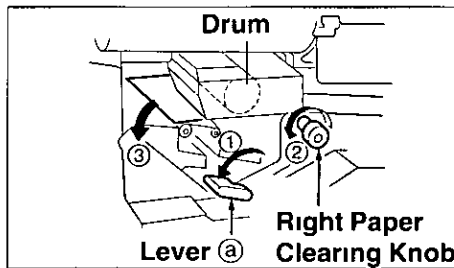

- ① Lower lever Ⓐ
- ② Turn right paper clearing knob
- ③ Remove misfed paper
- ④ Close front panel

3

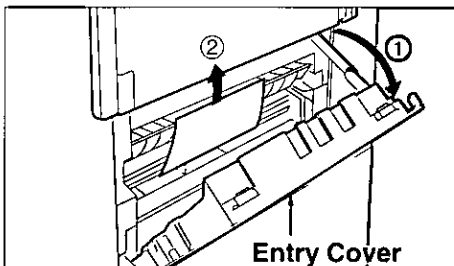

- ① Open entry cover
- ② Remove misfed paper
- ③ Close entry cover

### ATTENTION

- Do not touch or scratch the surface of the drum

■ Automatic Duplex Unit/except FP-7718

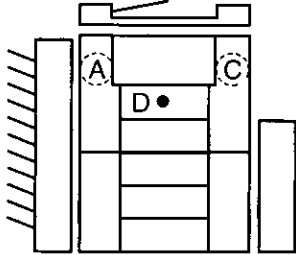

1

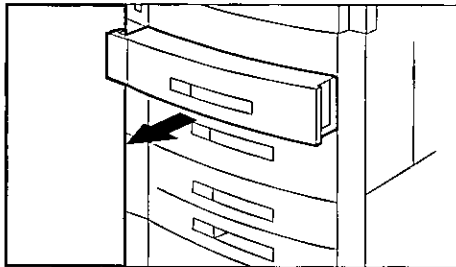

Pull out automatic duplex unit

2

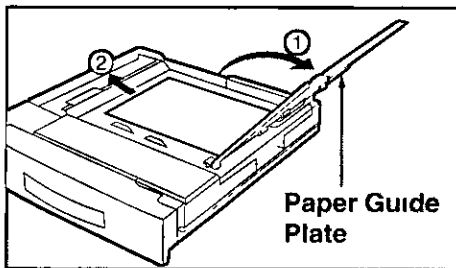

- ① Open paper guide plate
- ② Remove misfed paper
- ③ Close paper guide plate

3

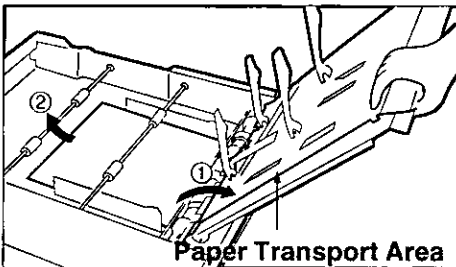

If misfeed is too far into the automatic duplex unit

- ① Open paper transport section, until it stops
- ② Remove misfed paper
- ③ Close paper transport section

4

Push automatic duplex unit back

**ATTENTION**

- When the misfeed indicators light at A, C and D, remove misfed paper from A and C first then remove it in the ADU (D)



# Removing a paper misfeed

8V (FP-7718/7722)/Remove misfed paper (FP-7728/7735)

## ■ System Console/Large Capacity Cassette

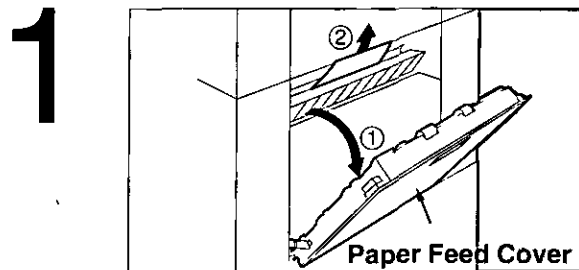
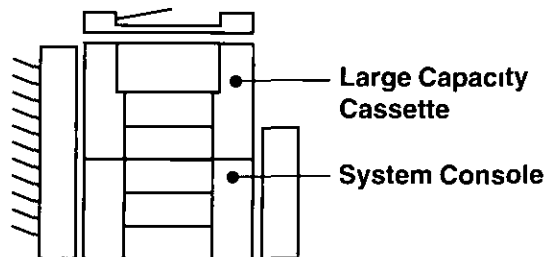

### System Console

- ① Open the paper feed cover
- ② Remove misfed paper
- ③ Close the paper feed cover

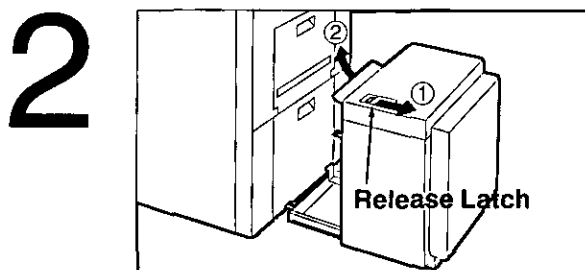

### Large Capacity Cassette

- ① Hold the latch and slide the large capacity cassette to the right
- ② Remove misfed paper

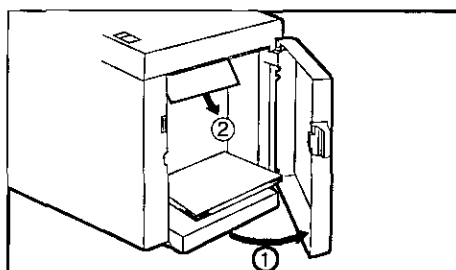

- ① Open the door
- ② Remove misfed paper
- ③ Close the door
- ④ Return the large capacity cassette to original position

■ i-ADF

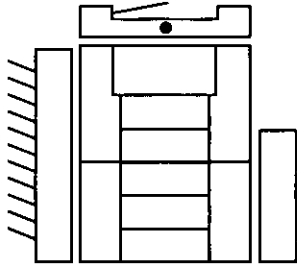

FP-7728/7735

Remove misfed orig  
in ADF

1

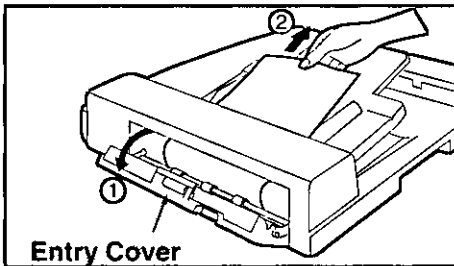

Entry Area

- ① Open entry cover
- ② Remove misfed paper
- ③ Close entry cover

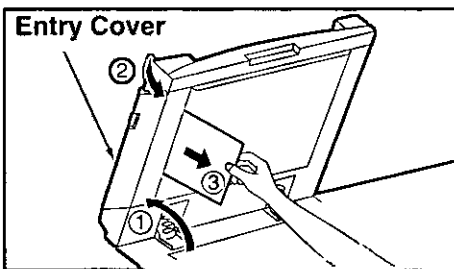

- ① Open the i-ADF
- ② Open entry cover
- ③ Remove misfed paper
- ④ Close the i-ADF

2

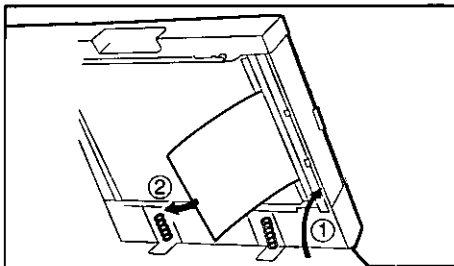

Exit Area

- ① Open the i-ADF
- ② Remove misfed paper  
If paper is remaining on the platen  
glass, remove it

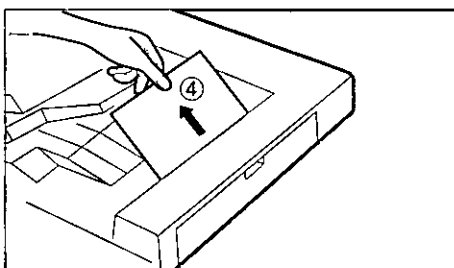

If paper can not be removed

- ③ Close the i-ADF
- ④ Open exit cover
- ⑤ Remove misfed paper
- ⑥ Close exit cover

**ATTENTION**

- Check that the paper misfeed indicator disappears

# Removing a paper misfeed

8√ (FP-7718/7722)

## ■ ADF

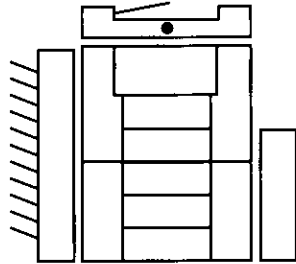

FP-7728/7735

Remove misfed orig  
in ADF

1

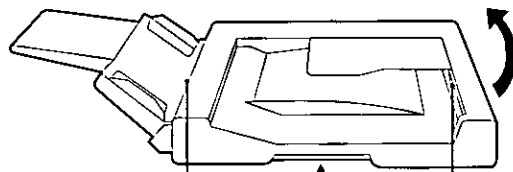

Open the ADF

Entry Area    Platen Area    Exit Area

2

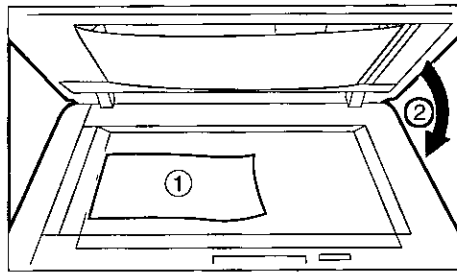

Platen Area

- ① Remove misfed paper
- ② Close the ADF

3



Entry Area

- ① Push the Release key and remove misfed paper
- ② Close the ADF

4

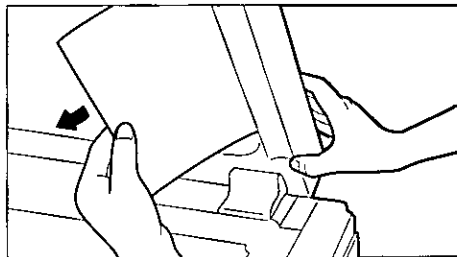

Exit Area

- ① Remove misfed paper
- ② Close the ADF

### ATTENTION

- Check that the paper misfeed indicator disappears

■ **Sorter**

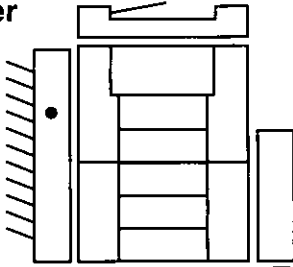

FP-7728/7735

Remove misfed paper

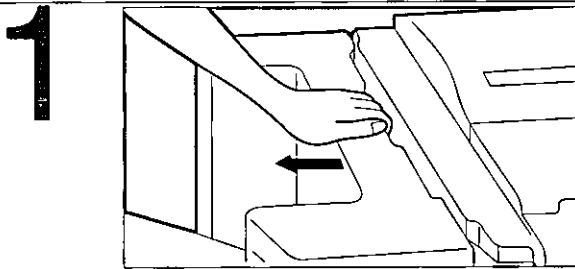

Pull sorter towards you slowly until it stops

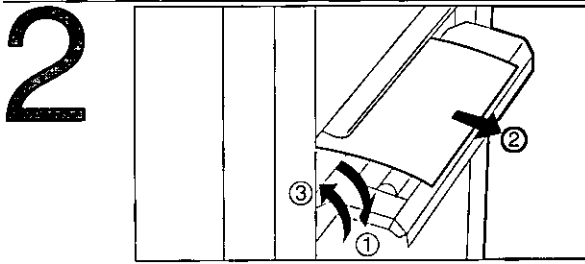

**For FA-S575/S615**

- ① Open transport cover (FA-S575)
- ② Remove misfed paper
- ③ Close transport cover (FA-S575)

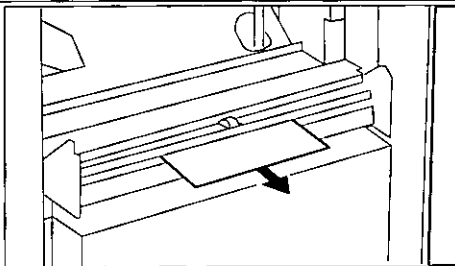

**For FA-S680**

Remove misfed paper

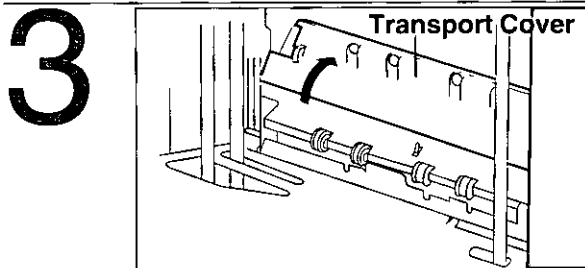

**For FA-S680**

- ① Open transport cover
- ② Check that paper is removed completely
- ③ Close transport cover



Slide the sorter against the copier

**ATTENTION**

- Check that the paper misfeed indicator disappears

# Troubleshooting

## Before you call service

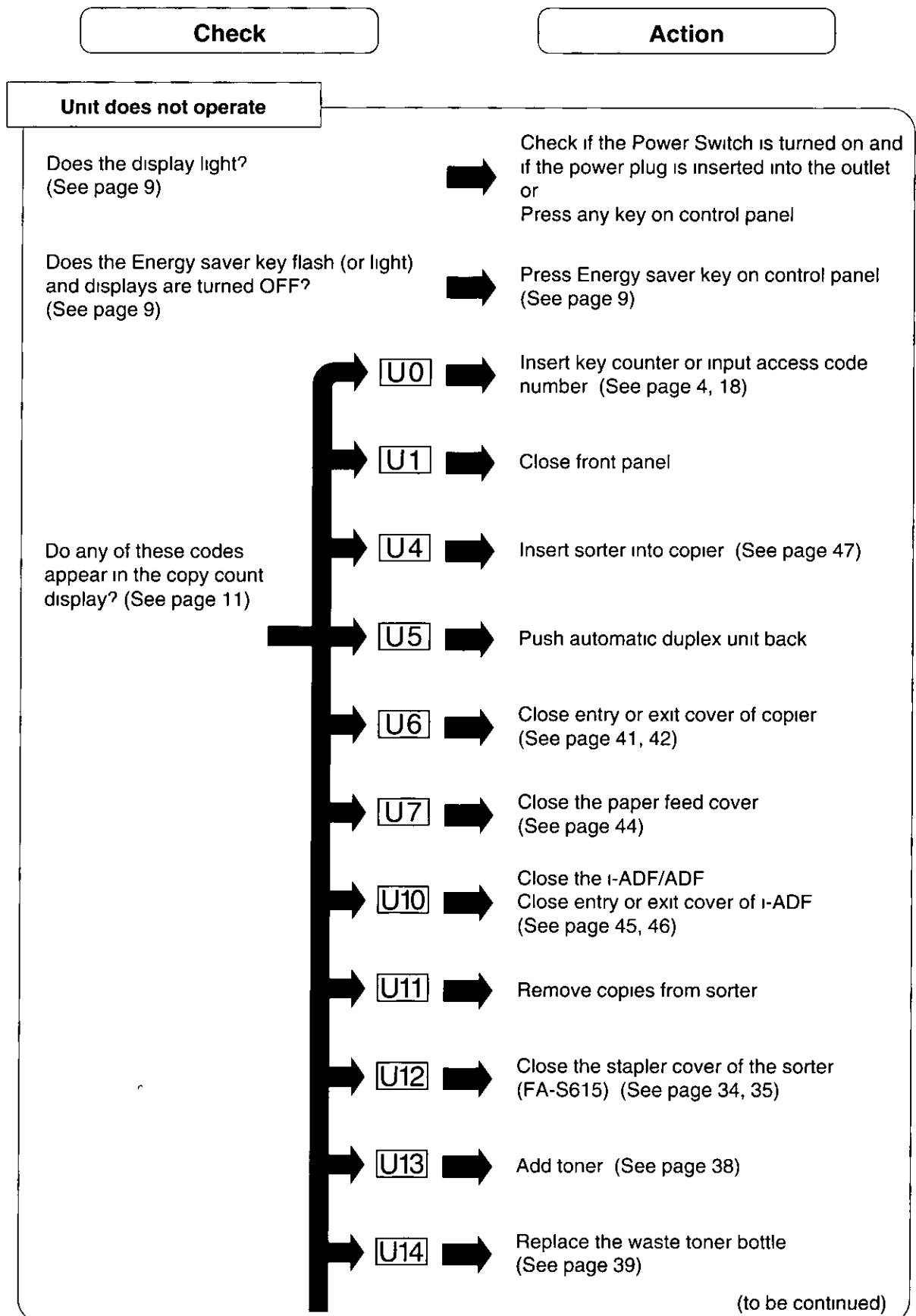

(to be continued)



## Check

## Action

### Unit does not operate

Do any of these codes appear in the copy count display? (See page 11)

U17

Close the transport cover of sorter (FA-S680) (See page 47)

U18

Department copy usage is limited, consult key operator

oF

Remove copies from the sorter bin(s), and press the Sorter Mode Select key (See page 32)

Does display indicate and **E** and **oF** alternately? (See page 11)

Turn copier off, then on. If error code does not go off, call service (E2-01 to E2-07 Select another cassette to continue copy job)

Does paper misfeed indicator light? (8V) (FP-7718/7722)

Is message "Remove misfed paper" or "Remove misfed orig in ADF" on the display? (FP-7728/7735)

Remove misfed paper (See page 40 - 47)

### Copies are light

Does the exposure indicator say "light"?

Touch the "dark" key or touch the "Auto" key to choose the auto mode

Does U13 appear in the copy count display?

Add toner (See page 38)

### Copies are marked

Is the copier platen glass or platen cover dirty?

Clean it

If the measures outlined above do not solve the problem, call Service

# Specifications

## ■ FP-7718/7722/7728/7735

Type	Desktop
Process	UltraMagnefine™ Toner
Multi Copy Speed	Letter size copies per minute 18 (FP-7718), 22 (FP-7722), 28 (FP-7728), 35 (FP-7735)
Maximum Copy Size	11" × 17" (Ledger size) Void Area max 5 0 mm
Copy Size	Invoice, Letter, Letter R, Legal, Ledger via paper drawer/tray 4" × 6" — 11" × 17" via sheet bypass
Reduction Ratios	Preset 50%, 61%, 65%, 77%, 79% Variable from 99% to 50% in 1% increments
Enlargement Ratios	Preset 121%, 129%, 155%, 200% Variable from 101% to 200% in 1% increments
Paper Feed	550 sheet paper drawer plus 50 sheet Bypass Automatic Switching
Paper Selection	Automatic
Paper Weight	16 – 24 lbs (15 – 30 lbs via sheet bypass)
Quantity Selector	1 – 999 (99 FP-7718), Automatic Repeat, Automatic Reset to 1
Exposure Control	Automatic/Manual plus Photo Mode
Toner Supply	Automatic
Dimensions	23 9" (W) × 26 0" (D) × 22 9" (18 9" FP-7718) (H)
Weight	138 lbs (FP-7718), 153 lbs (FP-7722), 150 lbs (FP-7728/7735)
Electrical Requirement	AC 120V, 60Hz, 12A

## ■ i-ADF (FA-A888), ADF (FA-A505)

Original Capacity	30 sheets/legal, ledger 50 sheets/invoice, letter
Paper Size	Invoice, Letter, Letter R, Legal, Ledger
Paper Weight	14 – 28 lbs
Electrical Requirement	Supplied from copier
Dimensions	22 8" (W) × 18 9" (D) × 3 7" (H) without Tray (FA-A505) 23 6" (W) × 20 2" (D) × 4 7" (H) without Tray (FA-A888)
Weight	22 0 lbs (FA-A505) 26 4 lbs (FA-A888)

Specifications are subject to change without notice

## ■ 20 Bin Sorter (FA-S575/S680)

	FA-S575	FA-S680 (Staple)
Paper Size	Invoice/Letter/Letter R/Legal/Ledger	Invoice/Letter/Letter R/Legal/Ledger
Paper Weight	16 – 24 lbs	16 – 24 lbs
Number of Bins	20	20 Plus Nonsort tray
Bin Capacity		
Non sort	Top bin 150 sheets (90 Sheets/ADU) Bins 2-20 50 sheets	Nonsort tray 100 sheets Bins 1-20 30 sheets (25 Sheets/Letter R, Legal, Ledger)
Staple sort	—	50 sheets (30 Sheets/Ledger) (Except Invoice size)
Sort	50 sheets	50 sheets (30 Sheets/Ledger)
Group	Top bin 150 sheets Bins 2-20 50 sheets	50 sheets (30 Sheets/Ledger)
Electrical Requirements	Supplied from copier	Supplied from copier
Dimensions	14 2" (W) × 19 2" (D) × 38 4" (H)	22 3" (W) × 20 9" (D) × 38 3" (H)
Weight	72 6 lbs	99 0 lbs

## ■ 10 Bin Sorter (FA-S280/S615)

	FA-S280	FA-S615
Paper Size	Letter/Letter R/Legal/Ledger	Letter/Letter R/Legal/Ledger
Paper Weight	16 – 24 lbs	16 – 20 lbs
Number of Bins	10	10
Bin Capacity		
Non sort	Top bin 100 sheets	Top bin 100 sheets
Staple sort	—	20 sheets/Letter, 15 sheets/Letter R or Legal, 10 sheets/Ledger
Sort	30 sheets (20 sheets/Legal, Letter)	30 sheets/Letter/Letter R, 25 sheets/Legal, 10 sheets/Ledger
Group	20 sheets (15 sheets/Legal, Letter)	20 sheets (10 sheets/Ledger)
Electrical Requirements	Supplied from copier	Supplied from copier
Dimensions	17 6" (W) × 17 8" (D) × 8 8" (H)	13 1" (W) × 22 0" (D) × 14 1" (H)
Mass (Weight)	17 6 lbs	22 0 lbs

Specifications are subject to change without notice

# Specifications

## ■ System Console (FA-DS72)

Combination	Storage Drawer × 1
Paper Size	Invoice, Letter, Letter R, Legal, Ledger
Paper Weight	16 – 24 lbs
Electrical Requirements	Supplied from copier
Dimensions	23 9" (W) × 25 0" (D) × 16 4" (H)
Weight	47 7 lbs

## ■ Large Capacity Cassette (FA-MA301)/Automatic Duplex Unit (FA-MADM6)

	FA-MA301	FA-MADM6
Paper Size	Letter	Invoice, Letter, Letter R, Legal, Ledger
Paper Weight	16 – 24 lbs	16 – 24 lbs
Paper Capacity	Maximum 3000 sheets, 20 lbs	Maximum 50 sheets, 20 lbs
Electrical Requirements	Supplied from system console	Supplied from copier
Dimensions	11 4" (W) × 17 5" (D) × 20 4" (H)	—
Weight	30 8 lbs	—

Specifications are subject to change without notice

**U.S.A. only**

### WARRANTY

"PANASONIC OFFICE PRODUCTS COMPANY MAKES NO WARRANTIES, GUARANTEES OR REPRESENTATIONS, EXPRESSED OR IMPLIED, TO CUSTOMER WITH RESPECT TO THIS PANASONIC COPIER, INCLUDING BUT NOT LIMITED TO, ANY IMPLIED WARRANTY OF MERCHANTABILITY OR FITNESS FOR A PARTICULAR PURPOSE

PANASONIC OFFICE PRODUCTS COMPANY ASSUMES NO RISK AND SHALL NOT BE SUBJECT TO LIABILITY FOR ANY DAMAGE, INCLUDING, BUT NOT LIMITED TO DIRECT, INDIRECT, SPECIAL, INCIDENTAL OR CONSEQUENTIAL DAMAGES OR LOSS OF PROFITS SUSTAINED BY THE CUSTOMER IN CONNECTION WITH THE USE OR APPLICATION OF THIS PANASONIC COPIER. SEE YOUR DEALER FOR DETAILS OF DEALER'S WARRANTY "

For Service Call \_\_\_\_\_

Panasonic Office Products Company  
A unit of Matsushita Electric Corporation of America  
Plain Paper Copier Division  
Two Panasonic Way, Secaucus, N J 07094

Matsushita Electric of Canada Limited  
5770 Ambler Drive, Mississauga,  
Ontario L4W 2T3

FFPTD0757 Printed in Japan  
September 1996  
S0996-0